

COATS®

90224

Rim Clamp® Tire Changer

*For servicing single piece automotive
and most light truck tire/wheel
assemblies*



Parts Identification

READ these instructions before placing unit in service KEEP these and other materials delivered with the unit in a binder near the machine for ease of reference by supervisors and operators.

HENNESSY INDUSTRIES, INC.

1601 J. P. Hennessy Drive, LaVergne, TN USA 37086-3565 615/641-7553 800/688-6359 www.ammcoats.com
HENNESSY INDUSTRIES INC. Manufacturer of AMMCO®, COAT® and BADA® Automotive Service Equipment and Tools.

Manual Part No.: 8184378 01
Revision: 04/09

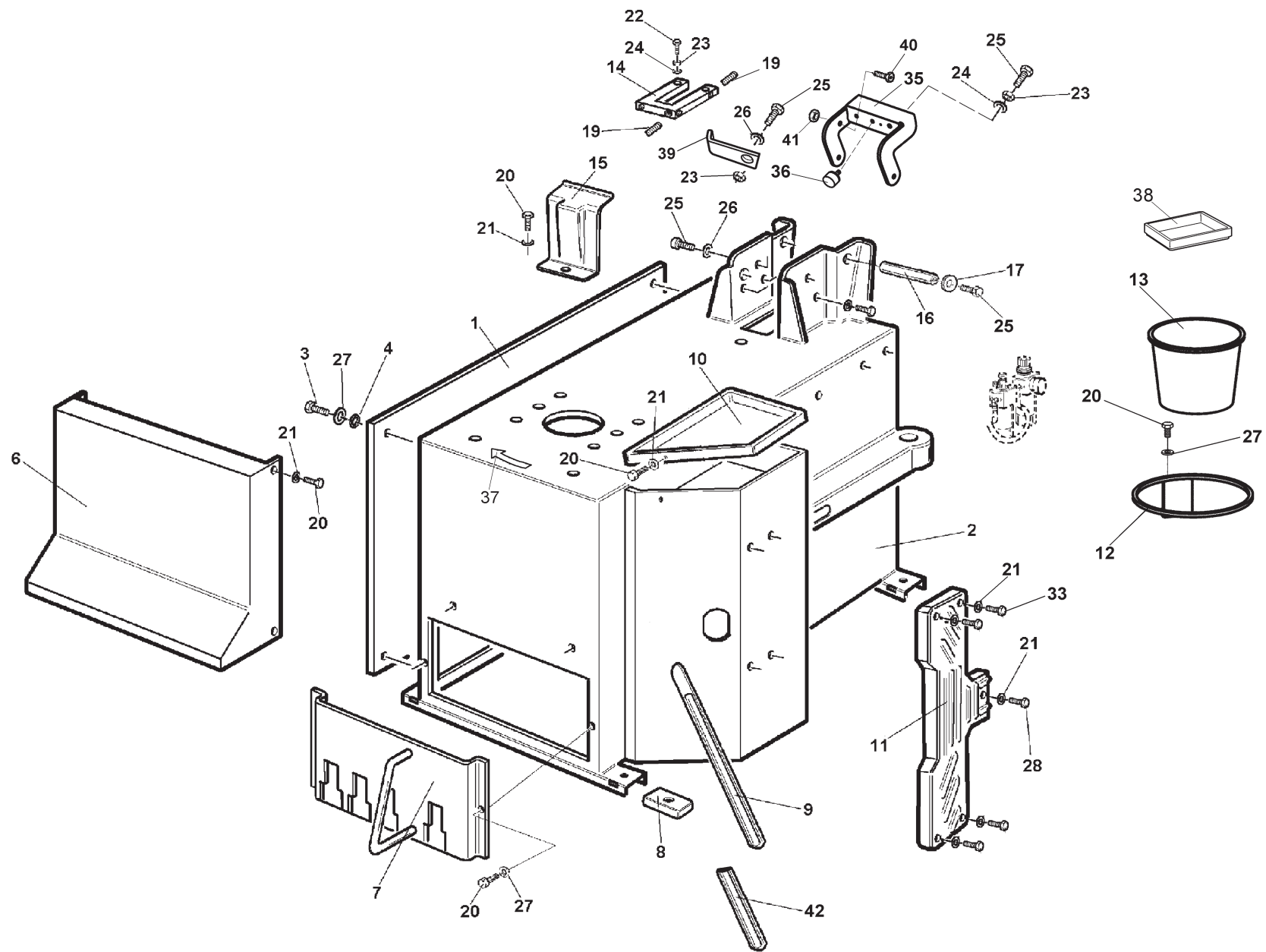

1	7912268	Side Cover	COPERCHIO LAT.8041-ROSSO3003	40	4399298	Screw 8x16	VITE TCEI M 8x16 8.8
2	7911982	Chassis Body	CARCASSA	41	4399976	Nut M8	DADO M 8 6S
3	4398708	Screw 6x16	VITE TE 6x16 8.8 5739	42	3002798	Lever cover	PROTEZIONE LEVA ALZATALLONI
4	4399288	Washer Toothed 6,4x11x0,7	ROND. DEN.ES."A" 6,4x11x0,7				
6	6612729	Pedal Cover	COFANO PROT.PED.W.-NERO				
7	6612453	Pedal Support	SUPPORTO PEDAL.8041-NERO				
8	3002099	Plastic Foot	PIEDE IN PLASTICA PER CARCASSA				
9	3006970	Bead Lifting Lever	LEVA ALZATALLONI TIPO C				
10	3011972	Cover	COP.APP.STALLONATORE ABS-NERO				
11	3002102	Wheel Support	APPOGGIO RUOTA INTEGRALE				
12	2108963	Spring	SUPP. VASO GRASSO -ZNT B.				
13	3008610	Grease Cup	VASO GRASSO COATS 183710				
14	3012312	Spacer	DISTANZ.SUPP.PALO 8041-BRUN.				
15	3012450	Cover Protection	PROTEZ.ANT.PALO V.224ABS-NERO				
16	3000206	Trunnion	PERNO FULCRO PALO VERTICALE				
17	3000495	Washer D.10x36x5	RONDELLA D. 10x36x5 -BRUNITA				
19	4399957	Screw 6x8	VITE STEI 6x8 P.COPPA 5929				
20	4398723	Screw 6x12 - 8.8	VITE TE 6x12 8.8 5739				
21	4398848	Washer 6 (6,6x18x1,5)	RONDELLA 6 (6,6x18x1,5)ZNT6593				
22	4399880	Screw 10x40	VITE TE 10x40 8.8 5739				
23	4399967	Nut M10	DADO M10 6S BASSO ZNT 5589				
24	4398662	Washer Grower D.10	ROND.GROWER D.10 ZNT 1751				
25	4399228	Screw 10x25	VITE TE 10x25 8.8 5739				
26	4399378	Washer D.10 (10,5x21x2)	RONDELLA 10 (10,5x21x2)ZNT6592				
27	4399998	Washer 6 (6,4x12x1,6)	RONDELLA 6 (6,4x12x1,6)ZNT6592				
28	4399584	Screw 6x18	VITE TCEI M 6x18 8.8 5931				
33	4399999	Screw 6x25	VITE TCEI M 6x25 8.8 5931				
35	6613334	Tilting tower Support	STAFFA FINE CORSA-ROSSO R3003				
36	4296213	Shock-Absorber 30/20 M8	ANTIVIBRANTE LAGOS 30/20 M8				
37	3000048	Arrow decal	ADESIVO FRECCIA ROTAZIONE				
38	4299988	Tray	VASCHETTA				
39	3008991	Keep plate	PIASTRINA FERMO TUBO GT				

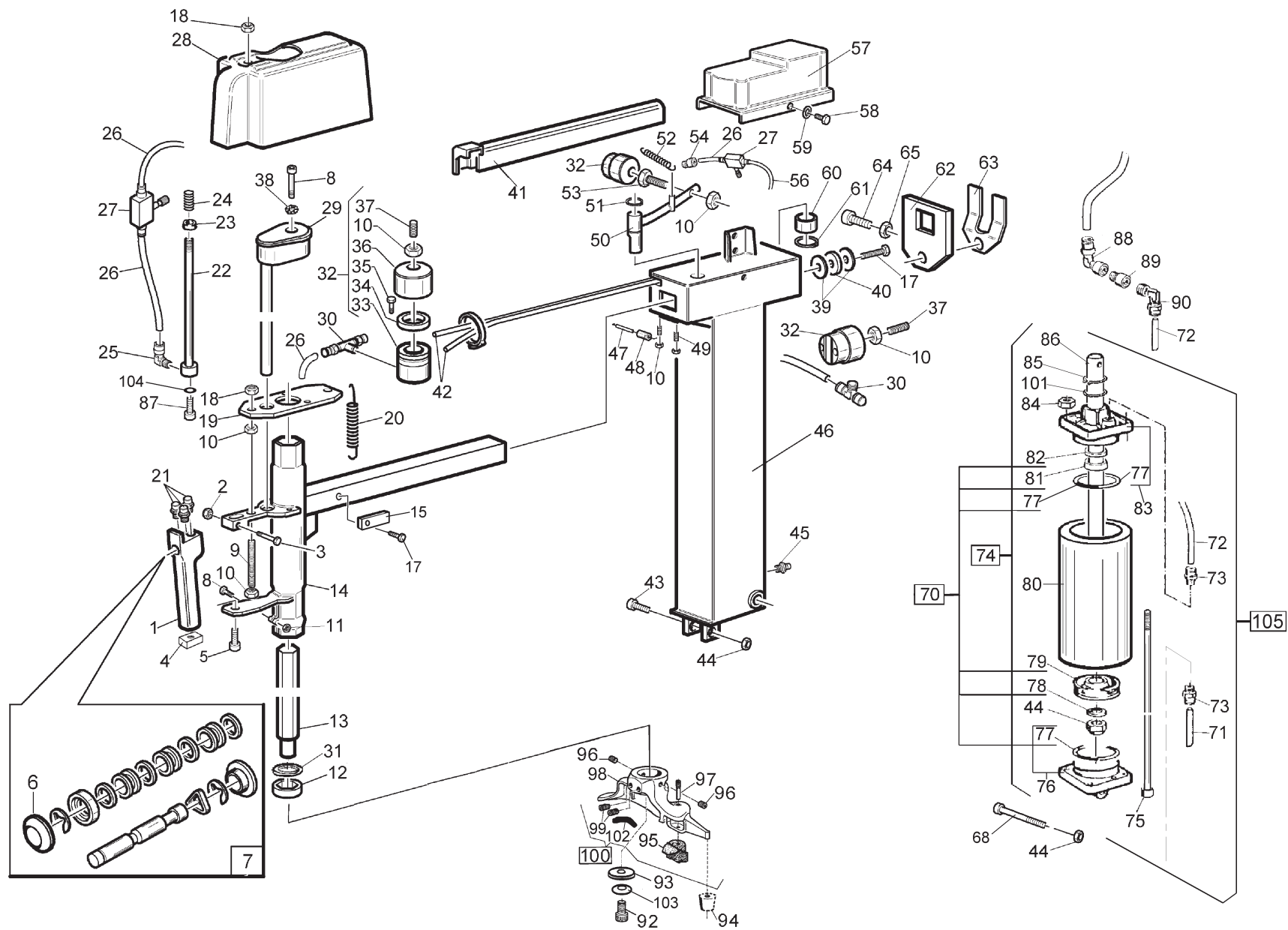

1	2012461	Robot Control Group	GR.COMANDO ROBOT INT.231	34	4299522	Sealing Ring	ANELLO TENUTA DEP 60-50-5
2	4399895	Nut Self-Locking M4	DADO AUTOBL.M 4 BASSO.6S. 7474	35	4399135	Screw 6x35	VITE TCEI M 6x35 8.8 5931
3	4399896	Screw 4x35	VITE TE 4x35 8.8 P.F. 5737	36	4299524	Cylinder Liner D.60	CAMICIA CILINDRO D.60
4	3013355	Handle Insert	INSERTO MANIGLIA	37	4398284	Screw 10x30	VITE STEI 10x30 P.P. 5923
5	4399892	Screw M6x20 - 8.8	VITE TE 6x20 8.8 5739	38	4399122	Toothed Washer 8,4x15x0,8	ROND. DEN.ES."A" 8,4x15x0,8
6	3012721	Cap	CAPPUCCIO ALLUM.	39	4399947	Washer 8 (9x32x4)	RONDELLA 8 (9x32x4) ZNT 6593
7	2008335	Arm Control Spares	KIT RICAMBIO X COMANDO ROBOT	40	3000181	Washer	RONDELLA AMM. MOTORE
8	4399133	Screw 8x40	VITE TCEI M 8x40 8.8 5931	41	3008915	Pipe Guide	GUIDA TUBI PALO Q.COATS-NERO
9	3012459	Threaded Bar M10 L=120	BARRA FILETT. M10 L=120	42	3013424	Rilsan Hose 4x2,7 L=2620	TUBO RILSAN BINATO 4X2,7 L=2620
10	4399967	Nut M10	DADO M10 6S BASSO ZNT 5589	43	3000599	Pin M12 L=50	PERNO X CROC. M12 L=50 TCEI (12.9)
11	4399900	Self-Locking Nut M8	DADO AUTOBL.M 8 BASSO 6.S 7474	44	4399865	Nut Self-Locking M12	DADO AUTOBL.M12 BASSO.6S. 7474
12	3002601	Mount. Head Shock Absorber	AMMORTIZ. TORRETTA ES.41	45	4399207	Lubricator M6	INGRASSATORE M6 (A)DRITTO 7663
13	3008889	Hexagonal Arm D.41 L=856	BRACCIO OP.ES.41 L=856	46	7911983	Vertical Arm	PALO VERT.RULLI S231-ROSSO 3003
14	6612521	Arm Horizontal	PALO QUADRO 8041-NERO	47	3008171	Roller	RULLO X TESTATA AUT. Q.60
15	3007935	Shock Absorber	AMMORTIZZ. PALO QUADRO AUT.	48	4397661	Parallel Pin 12x80	SPINA CIL.RETT. 12x80 6364A
17	4399827	Screw 8x20	VITE TE 8x20 8.8 5739	49	4398762	Screw 10x25	VITE STEI 10x25 P.CIL. 5925
18	4399971	Nut Self-Locking M10	DADO AUTOBL.M10 BASSO.6S. 7474	50	2112762	Locking Lever	LEVA BLOCC. PALO Q.S231-BRUN.
19	3006106	Arm Locking Plate	PIASTRA BLOCC.BO 41 MOON-BRUN.	51	4399979	Seeger Ring D.30	ANELLO SEEGER E D.30 7435
20	3002273	Spring	MOLLA A TRAZIONE—ZINC.	52	3000141	Spring	MOLLA RITORNO PEDALE
21	4197743	Union	RACCORDO 6511 M5-4 DIR. A.104	53	4399880	Screw Brass 10x40	VITE TE 10x40 8.8 5739
22	2008969	Inner Pipe	GR.CANNUCCIA INT.ROBOT 9010E	54	4197742	Quick Union 1/8"	RACCORDO 6510 1/8"-4 S.RAPIDO
23	4298812	Sealing Ring 8,4x16x6,2	ANELLO TENUTA SUR 8,4x16x6,2	56	3008355	Rilsan Hose 4x2 L=300	TUBO RILSAN 4x2 L=300
24	3002629	Spring 13,5x28 F 2,3	MOLLA COMPRES. 13,5x28 F 2,3	57	3011973	Cover	COP.SUP.TESTATA ABS-NERO
25	4197718	Union	RACCORDO 6520 M5-4 90' A.108	58	4398723	Screw 6x12 - 8.8	VITE TE 6x12 8.8 5739
26	3007990	Rilsan Hose 4x2 L=220	TUBO RILSAN 4x2 L=220	59	4399998	Washer 6 (6,4x12x1,6)	RONDELLA 6 (6,4x12x1,6)ZNT6592
27	4197703	Flow Regulator	REGOLATORE FLUSSO RFU 4-M5+R.	60	3000736	Bushing 16x25x15,25	BOCCOLA 16x25x15,25 CRBNTR
28	3012357	Arm Frame	CARENAT.ABS PALO Q.224N-NERO	61	4398686	Seeger Ring D.16	ANELLO SEEGER E D.16 7435
29	2008968	Outer Pipe	GR.CANNUCCIA EST.ROBOT C.9010E	62	2108115	Arm Locking Plate	PIASTRA BLOCC.P.Q. S.230-BRUN.
30	4197740	Quick Union 1/8"	RACCORDO 6410 1/8"-4 S.RAPIDO	63	3007839	Arm Locking Spring	MOLLA BLOCCAGGIO PALO Q.
31	3017974	Shock absorb. ring cover	COPERCHIO ANELLO AMMORTIZ. ES.41	64	4397527	Screw 8x30 - 10.9	VITE TBEI 8 x30 10.9 UBK
32	2099665	Locking Cylinder	CILINDRO BLOCCAGGIO	65	4399976	Nut M8	DADO M 8 6S ZNT 5588
33	4299523	Piston D.60	PISTONE D.60				

67	4398284	Screw 10x30	VITE STEI 10x30 P.P. 5923	102	3013650	Plastic insert	INSERTO INFER. X TORR. INTEGR.
68	4399539	Pin	PERNO RIBALTAMENTO	103	4395805	Wahser DIN6319 "C" 10,2x21x4	RONDELLA DIN6319 "C" 10,2x21x4
70	2004804	Cylinder Seal Kit	KIT GUARNIZ. CILINDRO D.75	104	4399292	Wahser 5 (5,3x10x1)	RONDELLA 5 (5,3x10x1)
71	3000217	Rilsan Hose 6x4 L=840	TUBO ELASTOLAN 6X4 L=840	105	2002831	Tilting cylinder	GR.CIL.RIBALT.EX BOLLINO ROSSO
72	3000218	Rilsan Hose 6x4 L=1200	TUBO ELASTOLAN 6X4 L=1200				
73	4198993	Quick Union 1/8" - 6	RACCORDO POC 1/8"-6 S.R.6510				
74	2008082	Tilting Cylinder	GR.CIL.RIB.EX BOLLINO ROSSO INT.				
75	3008085	Special Screw M8x160	VITE SPEC. TE M8x160 ZNT B.				
76	2015178	Rear Flange Group	GR. FLANGIA POSTER.D.75-PRF				
77	4298822	O-Ring D.68,26x3,53	ANELLO OR 842 D.68,26x3,53				
78	4398753	Washer D.12,5x30x3	RONDELLA 12,5x30x3 ZNT.				
79	4198856	Piston D.75	PISTONE MONOBLOCCO TDUOP D.75				
80	3008084	Cylinder Liner L=135	CAMICIA CIL.RIBALT. L=135				
81	3199601	Scraper	ANELLO RASCH.BID.L7 NSW 20 30 6/CO				
82	4299168	O-Ring 20,29x2,62	ANELLO OR 3081 D.20,29x2,62				
83	2015177	Front Flange Group	GR. FLANGIA ANTER. D.75-PRF				
84	4397678	Nut Flanged M8	DADO FLANGIATO M8 ZNT DIN 6923				
85	3199599	Seeger Ring D.30	ANELLO SEEGER I D.30 JV				
86	3002624	Cylinder Rod L=307	ASTA CILINDRO RIBALT. L=309				
87	4398897	Screw 5x20	VITE TE 5x20 8.8 5739				
88	4197210	Union 1/8"	RACCORDO 6521 1/8""-4 90' A.109				
89	4197209	Coupling 2543 1/8" F	MANICOTTO 2543 1/8"" F.				
90	4199098	Quick Union 1/8" 6-4	RACCORDO S6500 1/8" 6-4 S.RAPID				
92	4399953	Screw M10x16 - 8.8	VITE TE 10x16 8.8 5739				
93	4395804	Washer DIN6319 "G" 14,2x35x5	RONDELLA DIN6319 "G" 14,2x35x5				
94	3000215	Peak Roll	RULLINO PER UNGHIA				
95	3006689	Plastic Insert	INSERTO PLAST. X TORR. INTEGR.				
96	4395530	Screw STEI 12x12	VITE STEI 12x12 P.COPPA				
97	3009018	Special Pin.D.5 M6 L=26	PERNO SPEC.D.5 M6 L=26				
98	3015133	Short mounting tool	UTENSILE INT.OR.STRONG.				
99	4395529	Screw M12x16	VITE STEI 12x16 P.P.				
100	2014250	Mounting tool	TORR. INTEGR.OR.STRONG COMPL.				
101	4398146	Steel Shim 24x30x1	RASAMENTO 24x30x1				

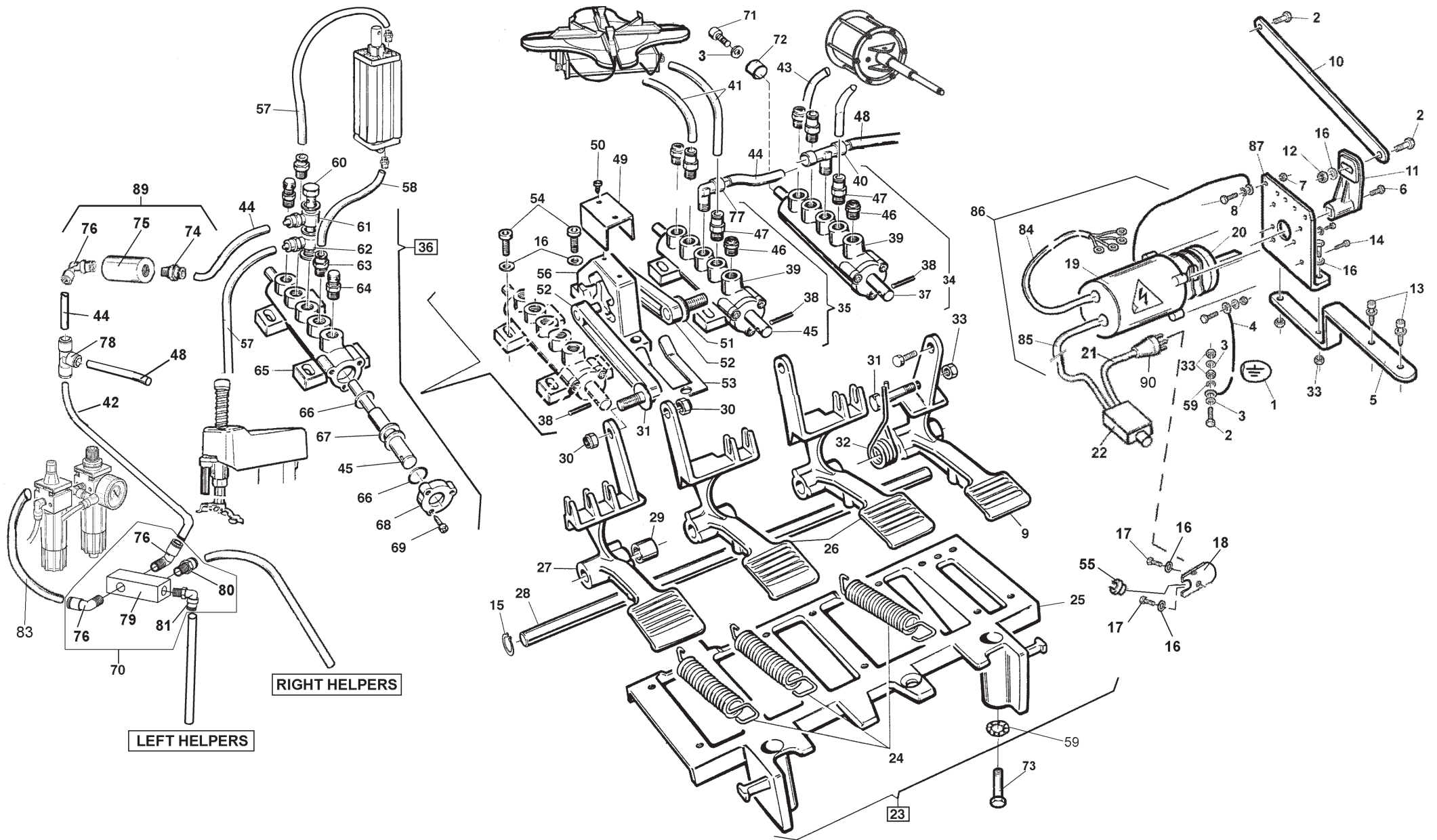

1	3005604	Sticker	DECALCO BOLLINO PE 27552 BSO	33	4399889	Nut M6	DADO M 6 6S ZNT 5588
2	4399892	Screw M6x20 - 8.8	VITE TE 6x20 8.8 5739	34	2006297	Valve Bead Breaking	GR.VALVOLA STALL. D.E.
3	4398848	Washer 6 (6,6x18x1,5)	RONDELLA 6 (6,6x18x1,5)ZNT6593	35	2002529	Valve Turntable	GR.VALVOLA AUTOC. LINEA
4	2006788	Ground Cable	CAVETTO TERRA SMTG AUTO L=500	36	2002531	Valve Tilting	GR.VALVOLA RIBALT. LINEA
5	3015342	Support	STAFFA SUPPORTO INVERT.-ZNT	37	3007598	Shaft Valve	ASTA VALVOLA COM.STALL.D.E.
6	4399905	Screw M4x12 8.8	VITE TE 4x12 8.8 5739	38	4398783	Pin Spring D.4x24	SPINA ELASTICA D.4x24 6874
7	4399996	Nut M4 6s	DADO M 4 6S ALTO ZNT 5587	39	2002444	Valve Assembly Without Pin	GR.VALVOLA LINEA SENZA PERNO
8	4399045	Toothed Washer 3,2x12x0,5	ROND. DEN.ES.IN. 3,2x12x0,5	40	4198778	Union 6410 1/8" - 8	RACCORDO 6410 1/8"-8 S.RAPIDO
9	3002157	Reverser Control Pedal	PEDALE COM.INVERT. ALL.	41	3099335	Hose Rilsan D.8x6 L=750	TUBO ELASTOLAN D. 8X6 L=750
10	3015341	Connecting Rod	BIELLA COM.INVERT.SAGOM.-ZNT	42	3001342	Hose Rilsan D.8x6 L-1000	TUBO ELASTOLAN D. 8X6 L=1000
11	3000175	Reverser Lever	LEVA INVERTITORE	43	3000889	Hose Rilsan D.8x6 L=910	TUBO ELASTOLAN D. 8X6 L=1100
12	4399893	Self Locking Nut M6	DADO AUTOBL.M 6 BASSO.6S. 7474	44	3002446	Hose Rilsan D.8x6 L=100	TUBO ELASTOLAN D. 8X6 L=100
13	4398273	Self Tapping Screw 5,5x19	VITE AUTOF. TCEI 5,5x19	45	3002442	Pin Valve	PERNO X VALVOLA GRIFFE/RIBALT.
14	4399044	Screw 3x12 12,9	VITE TCEI M 3x12 12,9 5931	46	4199610	Silencer 1/8"	SILENZIATORE 1 SFE 1/8"
15	4399864	Seeger Ring D.12	ANELLO SEEGER E D.12 7435	47	4198954	Quick Union 6510 1/8" - 8	RACCORDO POC 1/8"-8 S.R.6510
16	4399998	Washer 6 (6,4x12x1,6)	RONDELLA 6 (6,4x12x1,6)ZNT6592	48	3000145	Hose Rilsan D.8x6 L=250	TUBO ELASTOLAN D. 8X6 L=350
17	4398723	Screw M6x12	VITE TE 6x12 8.8 5739	49	4299910	Connecting Rod Guide	CAVALLOTTO GUIDA BIELLA
18	3019334	Support sheet iron	LAMIERINO SUPP. PRESSACAVO-BRUN.	50	4399891	Screw Self-Tapping 2,9x6,5	VITE AUTOF.TC+ 2,9x6,5 ZNT
19	3015345	Cover	PROTEZIONE PER INVERTITORE	51	4399894	Washer Belleville 8,2x18x1	MOLLA TAZZA 8,2X18X1 2093
20	4595380	Reverser Switch 1 Ph, 32 A	INVERTITORE 3x32A	52	4299912	Connecting Rod	BIELLA PER CAMME
21	2019704	Power Cable	CAVO EL. ALIM. 1PH 9024E -GAE-	53	4299911	Spring Forked Leaf	BALESTRA A FORCELLA
22	4594105	Circuit Breaker - 25 Amp	PASTIGLIA TERMICA 25A 9024E	54	4398274	Screw Self Tapping 5,5x26	VITE AUTOF. TCEI 5,5x26
23	2006514	Pedal unit	PEDALIERA AUTOM. LEGA	55	4593991	Cable fastener	BLOCCAPASSAC. BM13623
24	3013333	Pedal Return Spring	MOLLA RICH.PEDALE	56	4299913	Double Cam	CAMMA DOPPIA
25	3002161	Pedal Box Base	BASAMENTO PEDALIERA	57	3000218	Hose Rilsan 6x4 L=1200	TUBO ELASTOLAN 6X4 L=1200
26	3002159	Pedal	PEDALE COM. AUTOC./STALL. ALL.	58	3000217	Hose Rilsan 6x4 L=840	TUBO ELASTOLAN 6X4 L=840
27	3002160	Tilting Control Pedal	PEDALE COM. RIBALT. ALL.	59	4399122	Washer Toothed 8,4x15x0,8	ROND. DEN.ES."A" 8,4x15x0,8
28	3003095	Pedal Alignment Pin	PERNO ALLIN.PED. L.336-ZNT B.	60	4199928	Union 1/8"	RACCORDO 1631-02 1/8"
29	3007953	Bushing D.18x12,5x21	BOCCOLA D.18x12,5x21 PED.INV.	61	4197819	Union 1/8" - 8-6	RACCORDO 6610 1/8"" 8/6 S.RAP.
30	4399900	Self Locking Nut M8	DADO AUTOBL.M 8 BASSO 6.S 7474	62	4199927	Union 1/8" - 6	RACCORDO 6610 1/8"" 6/4 S.RAP
31	4397649	Screw 6x50 8.8	VITE TE 6x50 8.8 PF ZNT 5737	63	4198993	Quick Union 1/8" - 6	RACCORDO POC 1/8"-6 S.R.6510
32	3000142	Spring Control Pedal	MOLLA COMANDO PEDALE INV.				

64	4199843	Adjuster 1/8" Silencer Outlet	REGOL.SCAR.SILENZ.SVE 1/8"
65	3001583	Valve Distribution	VALVOLA DISTRIB.-SENZA CHIAVET
66	4299000	O-Ring 9,8x3,85	ANELLO OR 9,8x3,85
67	3001584	Spacer For Valve 3001583	DISTANZIALE X VALVOLA 3001583
68	3001585	Flange For Valve 3001583	FLANGIA X VALVOLA 3001583
69	4398999	Screw Self-Tapping 3,5x13	VITE AUTOF. TCIC 3,5x13 6954
70	2008893	Pneumatic Divider Group	GR. RIPARTITORE PNEUM. 9010E
71	4399229	Screw M6x10	VITE TE 6x10 8.8 5739
72	4197629	Washer Nylon 1/8"	RONDELLA NYLON 1/8" 2665
73	4399946	Screw M8x16 - 8.8	VITE TE 8x16 8.8 5739
74	4198884	Quick Union 1/4" - 8	RACCORDO S6510 1/4"-8 S.R.
75	4198853	Unidirectional Valve 1/4"	VALVOLA UNIDIREZ. 1/4" A.1532
76	4198883	Quick Union 1/4" - 8	RACCORDO S6500 1/4"-8 S.RAPIDO
77	4198990	Quick Union 1/8"-8	RACCORDO S6500 1/8"-8 S.RAPIDO
78	4198594	Quick Union 1/8"-8	RACCORDO 6550 8/6 SUPERRAP.
79	3000670	Pneumatic Divider 1/4" - 1/8"	BLOCCHETTO 3 F1/4"-1 F1/8"
80	4198298	Quick Union 1/4" - 6	RACCORDO S6510 1/4"-6 S.R.
81	4199098	Quick Union 1/8" 6-4	RACCORDO S6500 1/8" 6-4 S.RAPID
83	3001382	Hose Rilsan D.8x6 L=850	TUBO RILSAN D.8x6 L=850
84	2017242	Mot.-inv. connecting cable	CAVO COLL.MOT.-INV.C.1PH COATS NEW
85	2015349	1PH Reverser connecting cable	CAVO COLL.TERM.-INV.C.1PH COATS
86	2017241	110 V-1PH 32 A Reverser	GR.INVERT. 1PH 32A COATS-110V NEW
87	3015340	Support	SUPPORTO INVERTITORE
88	4398723	Screw 6x12	VITE TE 6x12 8.8
89	2009509	Valve	GR.VALV.UNIDIR. COATS 9010E
90	4594208	Plug	SPINA 30A NEMA L5-30P 125V USA

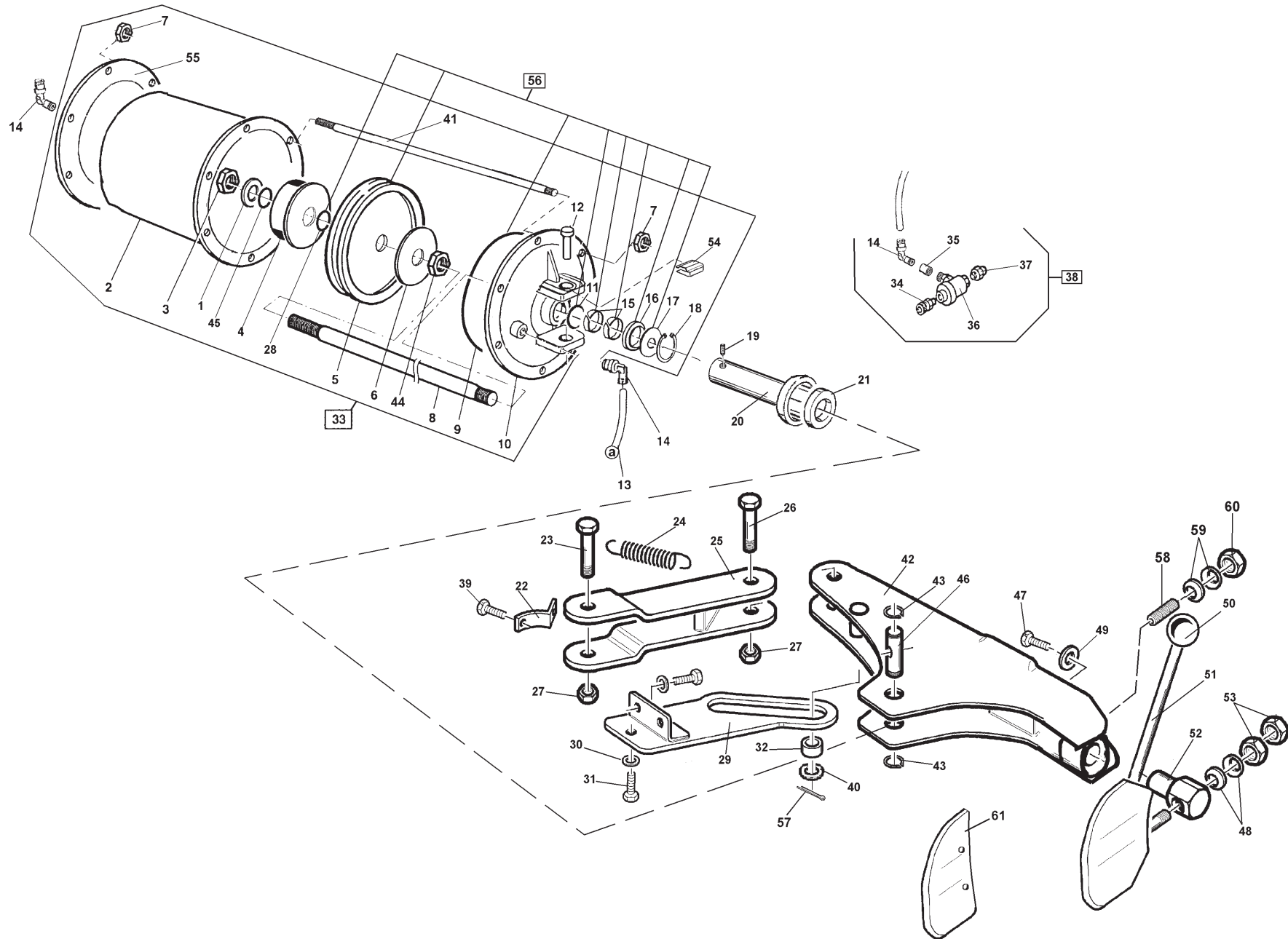

1	4398289	Washer 18 (19x34x3)	RONDELLA 18 (19x34x3) 6592	34	4198954	Quick Union 6510 1/8" - 8	RACCORDO POC 1/8"-8 S.R.6510
2	3009460	Cylinder Liner	CAMICIA CIL.ST. D.200 6F.10,5	35	4198894	Coupling 2543 1/4" F	MANICOTTO 2543 1/4" F.
3	4398725	Nut Self-Locking M18	DADO AUTOBL.MA18 ALTO DIN 982	36	4199671	Valve Quick Relief 1/4"	VALVOLA SCARICO RAPIDO DA 1/4"
4	3005809	Limit Stop	FINECORSIA CIL. STALL. D.200	37	4198808	Silencer 1/4"	SILENZIATORE 1/4" SPEC. D.24
5	4198186	Piston D.200	PISTONE MONOBL. TDUOP D.200/24	38	2008204	Valve Quick Relief	GR.VALVOLA SCAR.RAPIDO MOON
6	3006496	Washer 18x90	ROND.SP. 18x90 SP.4 D.E.ZNT B.	39	4399946	Screw M8x16 - 8.8	VITE TE 8x16 8.8 5739
7	4397401	Flanged Nut M10	DADO FLANGIATO M10 ZNT DIN6923	40	3007352	Washer 20,5X50X6	RONDELLA 20,5X50X6
8	3007852	Piston Rod D.20 L=525	ASTA PIST.STALL.DE D.20 L=525	41	3008812	Tie Rod M10 L=260	TIRANTE M10 L=260 - ZNT B.
9	4198145	O-Ring D.196.4x3,53	ANELLO OR 4775 D.196,4X3,53	42	6615975	Arm Bead Breaking	BRACCIOSTALLONNS24NERO
10	2109011	Flange	FLANG.ANT.CIL.STAL.9010-ZNT	43	4398178	Seeger Ring D.40	ANELLO SEEGER E D.40 7435
11	4299168	O-ring 20,29x2,62	ANELLO OR 3081 D.20,29x2,62	44	4398144	Nut M18	DADO M18 MEDIO 5588
12	3009017	Cylinder Pin	PERNO FULCRO CIL. STALL.	45	4297654	O-Ring D. 15,8x2,62	ANELLO OR 119 D.15,08x2,62
13	3000144	Hose 8x6 L=910	TUBO ELASTOLAN D. 8X6 L=910	46	3008990	Pin Pivot D.40	PERNO ORIENT. ASTA D.40-BRUN.
14	4198578	Quick Union 1/4"-8	RACCORDO S6500 1/4"-8 S.RAPIDO	47	3017947	Screw 14x12	VITE SPECIALE TE M14x12
15	4296509	Guide ring	ANELLO GUIDA WRI 20	48	4398899	Spring Belleville 14,3x34x1,5	MOLLA TAZZA 14,3x34x1,5
16	3199601	Scraper	ANELLO RASCH.BID.L7 NSW 20-30-6	49	4398751	Washer 14 (16x42x3)	RONDELLA 14 (16x42x3) 6593
17	4297654	Steel Shim 24x30x0,3	ANELLO OR 119 D.15,08x2,62	50	4299952	Knob D.12	POMOLO D.14
18	3199599	Seeger Ring D.30	ANELLO SEEGER I D.30 JV	51	2114858	Plate Bead Breaking	PALETTA STALL. COATS-ZINCATA
19	4396218	Screw 6x10	VITE STEI 6x10 P. PIATTA 5929	52	3015807	Trunnion	PERNO SNODO PAL. ES 50
20	2112754	Support	SUPP.AMMORTIZ.COMPL.-ZNT B.	53	4396941	Nut M14	DADO M14 6S BASSO ZNT 5589
21	3002117	Shock Absorb. D..21x63x12	AMMORTIZZ. D.21x63x12 POLIUR.	54	3009012	Clips	MOLLA A CLIPS
22	3012489	Spring Plate	PIASTRINA AGG. MOLLA-BRUN.	55	3008811	Cylinder Back Flange	FLANGIAPOST.CIL.STAL.9010-ZNT
23	4397455	Screw 16x140	VITE TE 16x140 8.8 5737	56	2009091	Cylinder Seal Kit	KIT GUARNIZ.PN. CIL D.E. D.200
24	3000114	Spring Arm	MOLLA BRACCIO STALLONATORE	57	4399192	Split Pin D.4x36	COPIGLIA D. 4X36 ZNT 1336
25	2111986	Trunnion	SNODO STALL.8041-BRUN.	58	4398956	Screw 12x60	VITE STEI 12x60 P.CONICA
26	4396312	Screw 16x110	VITE TE 16x110 8.8 P.F. 5737	59	4398944	Belleville washer 12,2x25x1,5	MOLLA TAZZA 12,2x25x1,5
27	4399963	Nut Self-Locking M16	DADO AUTOBL.M16 BASSO.6S. 7474	60	4399865	Self-locking nut M12	DADO AUTOBL.M12 BASSO
28	4297585	O-Ring D.15,47x3,53	ANELLO OR 4061 D.15,47x3,53	61	3013240	Protective Cover	PROTEZ.PALETTA SCATTO NYLON
29	2111987	Guide	GUIDA STALL.230N-BRUN.				
30	4399378	Washer D.10 (10,5x21x2)	RONDELLA 10 (10,5x21x2)ZNT6592				
31	4399228	Screw M10x25 - 8.8	VITE TE 10x25 8.8 5739				
32	3001039	Roller	RULLO FERMO BRACCIO				
33	2013417	Cylinder Bead Breaker	GR.CIL.STALL. D.E. COATS 9024				

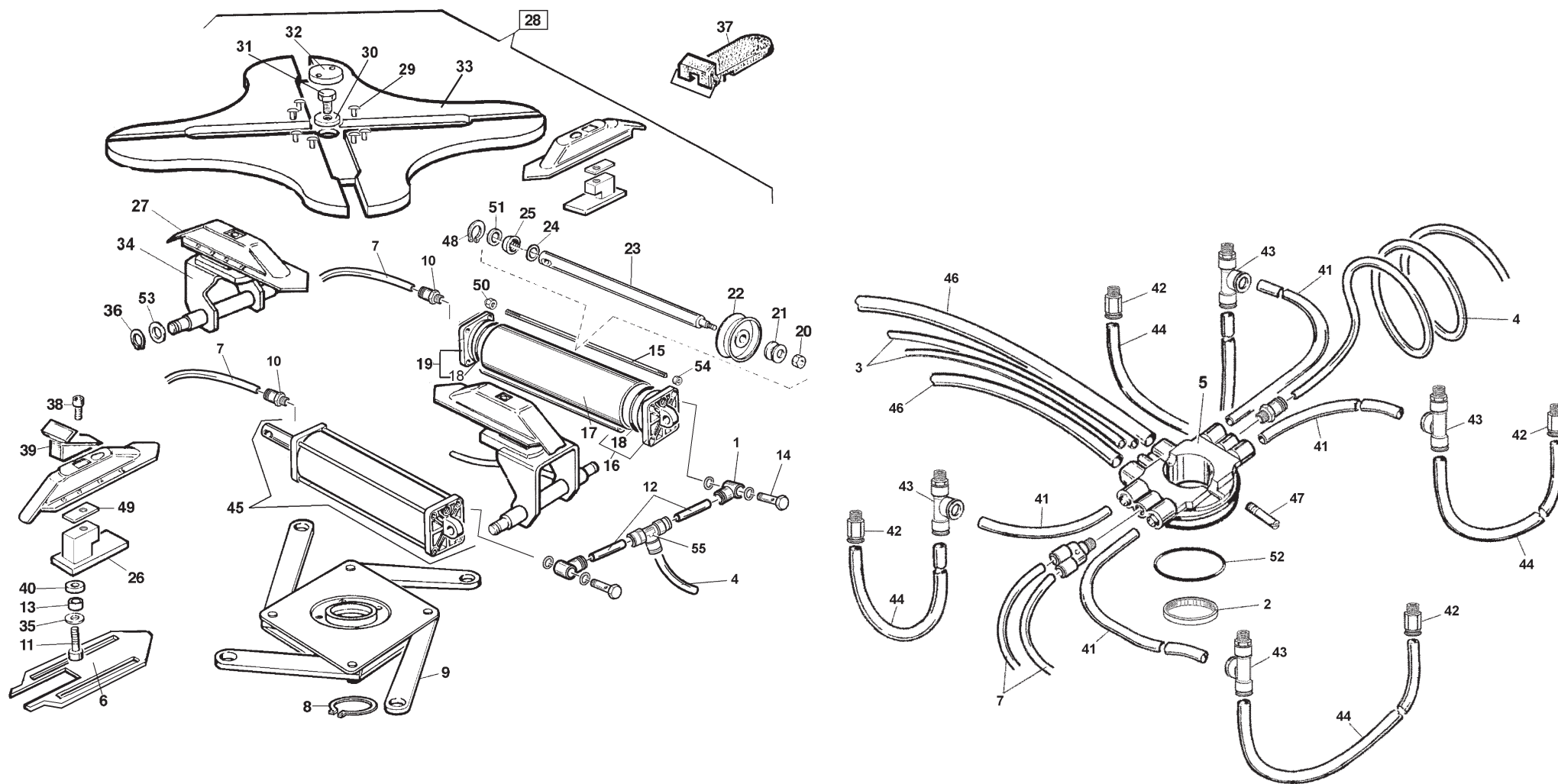

1	4197819	Quick union 1/8" 8-6	RACCORDO 6610 1/8"" 8/6 S.RAP.	33	2111874	Turntable 24" Square	PIATTO AUTOC. 24" STELLA - ZNT
2	3008646	Spacer O-Ring (D.55x1,5)	DISTANZ. X OR GT (D.55 x 1,5)	34	2112879	Pin Slide Guide	GUIDA SCOR.PERNO UNIF.-BRUNIT.
3	3099335	Hose Rilsan D.8x6 L=750	TUBO ELASTOLAN D. 8X6 L=750	35	4399981	Washer 12 (13x24x2,5)	RONDELLA 12 (13x24x2,5)ZNT6592
4	3016820	Rilsan spiral hose 8X6 L=560	SPIRALE RILSAN 8X6 L=560	36	4399864	Seeger Ring D.12	ANELLO SEEGER E D.12 7435
5	4295066	GT rotating "Y"-union	RACCORDO GIREVOLE "Y" GT	37	2006393	Clamp Cover	PROTEZ.INTEGRALE GRIFFA COMPL.
6	3015171	Plate 24" Turntable	PIASTRINA AUTOC.24"	38	4398037	Screw 10x1,25x25 12.9	VITE TCEI 10x1,25x25 12.9 TF
7	3000870	Hose 8x6 L=240	TUBO ELASTOLAN D. 8X6 L=240	39	3002297	Clamp Oversize	GRIFFA BLOCCAGGIO MAGGIORATA
8	4399932	Seeger Ring D.65	ANELLO SEEGER E D.65 7435	40	3006879	Spacer Turntable	DISTANZIALE AUTOC. UNIF.
9	2012472	Flange 24" Turntable	FLANGIA X AUTOC.24"	41	3006477	Hose 10x6,5 L=335	TUBO POLIUR.10X6,5 L=335
10	4198954	Quick union 1/8"	RACCORDO 6512 1/8"-8 S.R. (DIRITTO+OR)	42	4198035	Brass Union Pc10-02	RACCORDO DRITTO 1/4""-10 A.112
11	4398838	Screw M12x1,25x45	VITE TE 12x1,25x45 8.8 PF 5738	43	4197207	Union Tee 1/8" 10-8	RACCORDO T 1/8""-10/8 112
12	3016819	Elastolan hose 8X6 L=75	TUBO ELASTOLAN 8X6 L=75	44	3006478	Hose Polyuret. 10x6,5 L=310	TUBO POLIUR.10X6,5 L=310
13	3006880	Spacer Connecting Rod	DISTANZIALE BIELLA UNIF.	45	2008857	Cylinder 24" Turntable	GR.CILINDRO P.A.3 INT.
14	4199929	Union 1/8"	RACCORDO 1631-01 1/8"	46	3002109	Rilsan hose 14x11 L=1070	TUBO RILSAN 14X11 L=1070
15	3008860	Stud Bolt M8x1,25x437	VITE SPECIALE M8x1,25x431 ZNT	47	3001996	Screw	VITE X RACC.GIREV.TUBL.
16	2015178	Rear Flange Gr.	GR. FLANGIA POSTER.D.75-PRF	48	3199599	Seeger Ring D.30	ANELLO SEEGER I D.30 JV
17	3008858	Cylinder Liner L=402	CAMICIA CIL. P.A.3 L=402	49	3006877	Slide Shim	SPESSORE SCORR.UNIF. 3,5-BRUN.
18	4298822	O-Ring D.68,26x3,53	ANELLO OR 842 D.68,26x3,53	50	4397678	Nut Flanged M8	DADO FLANGIATO M8 ZNT DIN 6923
19	2015177	Front Flange Group	GR. FLANGIA ANTER. D.75-PRF	51	4398146	Steel Shim 24x30x0,3	RASAMENTO 24x30x1
20	4399865	Nut Self-Locking M12	DADO AUTOBL.M12 BASSO.6S. 7474	52	4297520	O-Ring 153 D.49,21x3,53	ANELLO OR 153 D.49,21X3,53
21	4398753	Washer D.12,5x30x3	RONDELLA 12,5x30x3 ZNT.	53	4398637	Washer D.12x21x2,5	RONDELLA 12x21x2,5 UNI1750 ZNT
22	4198856	Piston D.75	PISTONE MONOBLOCCO TDUOP D.75	54	4399976	Nut M8	DADO M 8 6S ZNT 5588
23	3008859	Cylinder Shaft D.20 L=458	ASTA CIL. P.A.3 L=453	55	4198978	Union	RACCORDO 6540 8
24	4299168	O-Ring 20,29x2,62	ANELLO OR 3081 D.20,29x2,62				
25	3199601	Scraper	ANELLO RASCH.BID.L7 NSW 20-30-6				
26	2112878	Slide Guide	GUIDA SCORR. UNIF. -BRUNIT.				
27	2107387	Gt Slide	SCORREVOLE GT UNIF.-ZNT B.				
28	2014235	Turntable 24" Gt	AUTOCENTRANTE 24" GT STELLA				
29	3015187	Pin Guide	PERNO GUIDA SCORREV				
30	3009778	Washer D.16x47x13	RONDELLA SPEC. D.16x47x13-ZNT				
31	4399926	Screw M16x1,5x40 - 8.8	VITE TE 16x1,5x40 8.8 5740				
32	3000062	Cap Turntable	PROTEZIONE CENTRALE PIATTO				

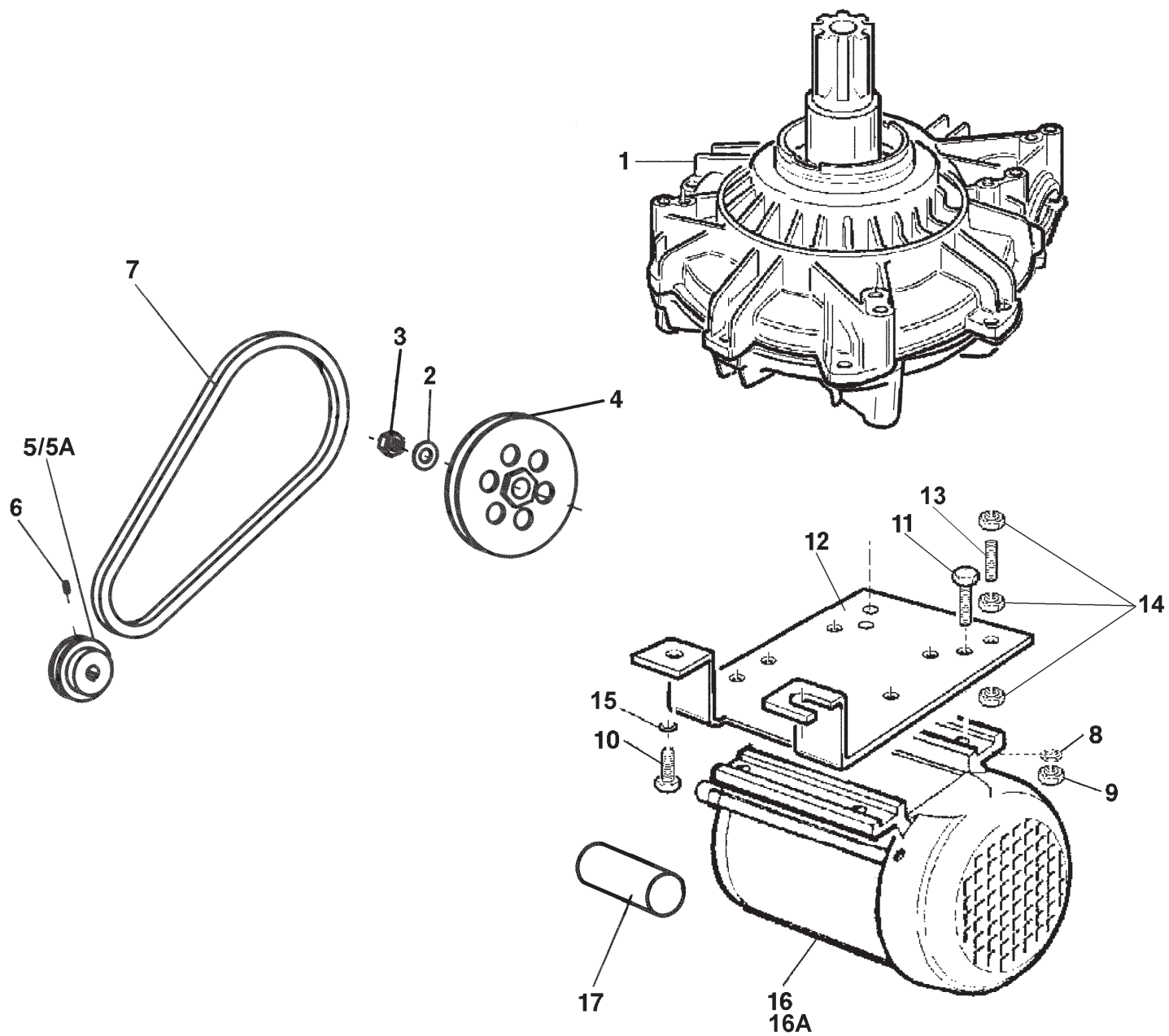

1	2011967	Transmission	GR.RIDUT.SMTG AUTO (A23) COMPL.
2	4398807	Washer 14 (15x28x2,5)	RONDELLA 14 (15x28x2,5)ZNT6592
3	4396941	Nut M14	DADO M14 6S BASSO ZNT 5589
4	3199596	Pulley Gearbox	PULEGGIA RIDUTTORE
5	3019133	Pulley Motor	PULEGGIA 5/8" SHAFT I=90" P.D.
5/A	2100166	Pulley Motor (220 v 1PH)	PULEGGIA MOTORE (220 v 1PH)
6	4396218	Screw 6x10	VITE STEI 6x10 P.P.
7	4299923	V-Belt A23	CINGHIA A 23
8	4399863	Washer 8 (9x24x2)	RONDELLA 8 (9x24x2) ZNT 6593
9	4399900	Self-Locking Nut M8	DADO AUTOBL.M 8 BASSO 6.S 7474
10	4399228	Screw 10x25	VITE TE 10x25 8.8
11	4399946	Screw Te M8x16 - 8.8	VITE TE 8x16 8.8 5739
12	3010803	Motor Support	SUPPORTO MOTORE COATS-ZNT B.
13	4397964	Screw 10x80	VITE STEI 10x80 P.CIL.
14	4399967	Nut M10	DADO M10 6S BASSO ZNT
15	4399662	Toothed washer 4,3x8x0,5	ROND. DEN.ES."A" 4,3x8x0,5 ZNT
16	4596185	Motor 2 Hp 115v 1ph	MOT.1PH 115V.60Hz 8184372 2HP COATS
16/A	4599914	Motor 1PH 230V 50HZ	MOT.1PH HP1,2 230V.50
17	4393948	Motor Capacitor Only	CONDENSATORE MOTORE

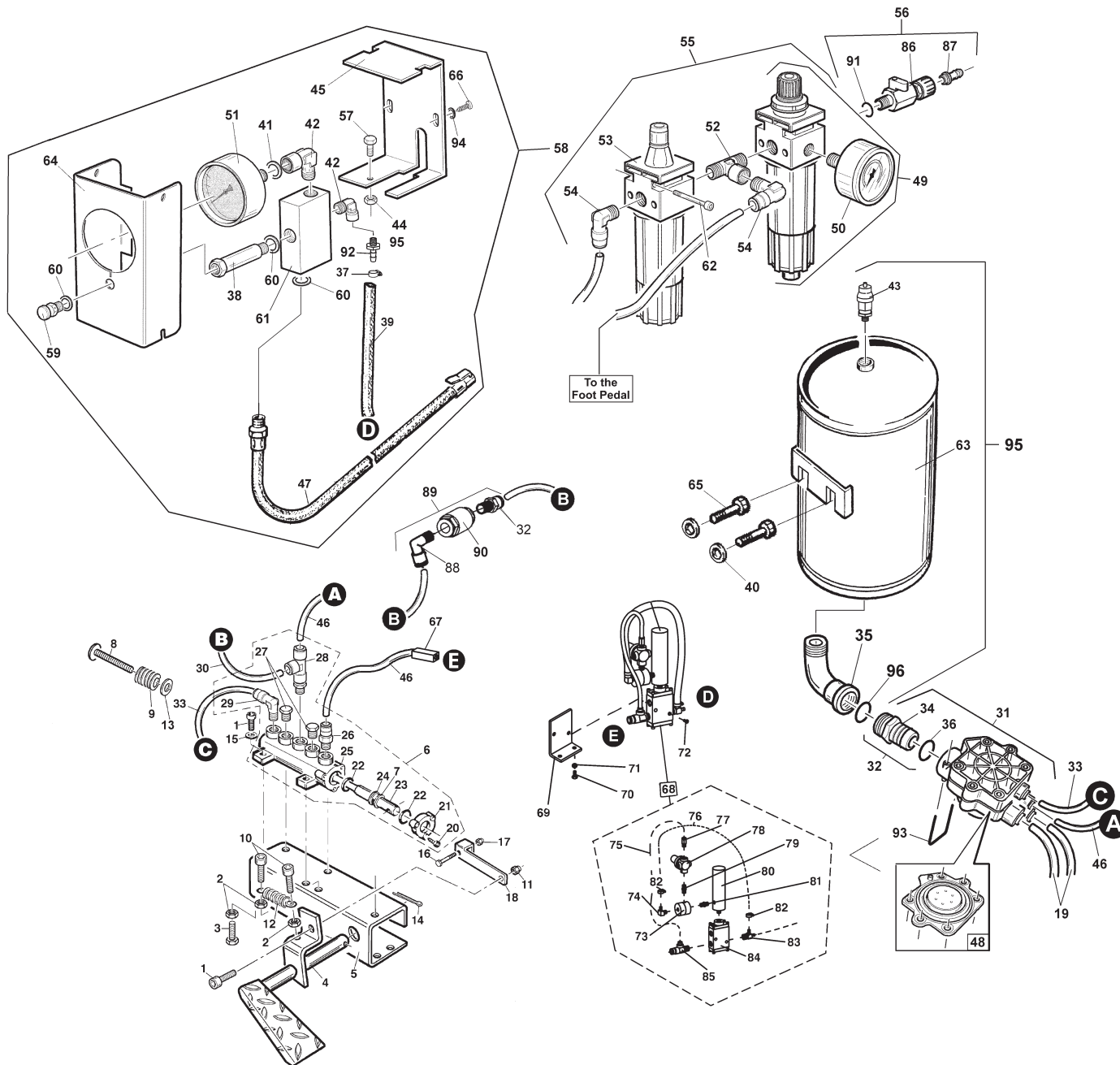

1	4399890	Screw M6x20 - 8.8	VITE TCEI M 6x20 8.8	5931	33	3002110	Hose Rilsan D.6x4 L=580	TUBO ELASTOLAN 6X4 L=580
2	4399889	Nut M6	DADO M 6 6S ZNT	5588	34	3017573	Quick union	RACCORDO INNESTO RAPIDO 1"-ZNT
3	4399892	Screw M6x20 - 8.8	VITE TE 6x20 8.8	5739	35	4194765	90° M/F 1" union	RACCORDO 90° M/F 1"-ZNT N.
4	2110288	Pedal Gt	PEDALINO GT -BRUNITO		36	4294755	O-ring 2100 D.25,12x1,78	ANELLO OR 2100 D.25,12x1,78
5	3010287	Pedal Support Gt	SUPPORTO PEDAL. GT-BRUNITO		37	4197390	Hose Clamp D.8X13 H9	FASCETTA AWAB D.8x13 h9
6	2009718	Valve Unit	GR.VALVOLA GT TN		38	4198670	Stud bolt 1/4" H=43	COLONNETTA 2525 1/4" H=43
7	4398634	Seeger ring D.10	ANELLO SEEGER E D.10		39	3009093	Hose D.6x12 L=1500	TUBO ARIANNA D.6x12 L=1500NERO
8	4399229	Screw 6x10	VITE TE 6x10 8.8		40	4398848	Washer M6 (6,6X11X1,5)	RONDELLA 6 (6,6x18x1,5)ZNT6593
9	4298942	Spring D.20x26	MOLLA GIALLA SL D.20x26		41	4299000	O-ring 9,8x3,85	ANELLO OR 9,8x3,85
10	4399999	Screw M6x25 - 8.8	VITE TCEI M 6x25 8.8	5931	42	4198908	Union 1/4"	RACCORDO 2020 1/4" F/M
11	4399893	Nut Self-Locking M6	DADO AUTOBL.M 6 BASSO.6S. 7474		43	4198703	Safety Valve 3/8" - 11bar	VALV.SIC.1/4"0/11 INAMOV.+ANELLO
12	3000141	Spring	MOLLA RITORNO PEDALE		44	4399976	Nut M8	DADO M 8
13	4398807	Washer 14 (15x28x2,5)	RONDELLA 14 (15x28x2,5)ZNT6592		45	6615109	GT back sheet	LAMIERA POSTER.GT-NERO BUCC.
14	4399100	Split Pin D.3,2x30	COPIGLIA D.3,2X30	1336	46	3099336	Hose Rilsan D. 8x6 L=540	TUBO RILSAN BIANCO 8x6 L=540
15	4399998	Washer 6 (6,4x12x1,6)	RONDELLA 6 (6,4x12x1,6)ZNT6592		47	2009045	Hose Gt Control Unit L=1500	GR.TUBO CENTR. GT 9010E L=1500
16	4399897	Screw M14x25 - 8.8	VITE TE 4x25 8.8 P.F.	5737	48	2017495	Valve diaphragm	MEMBRANA VALVOLA SOFFIAGGIO
17	4399895	Nut Self-Locking M4	DADO AUTOBL.M 4 BASSO.6S. 7474		49	4196480	Filter	FILTRO REG. 1/4" GRIGIO+MAN 0-16
18	3001853	Valve Control Lever	LEVETTA COMANDO VALVOLA -ZNT		50	4298308	Pressure gauge D.40	MANOMETRO D.40 0-25BAR/PSI/KPA
19	3002109	Hose Rilsan D.14x11 L=1070	TUBO RILSAN 14X11 L=1070		51	4198070	Flanged Air Gauge W/Fasteners	MANOMET.D.80 600KPA-6BAR-85PSI
20	4398999	Screw Self-Tapping 3,5x13	VITE AUTOF. TCIC 3,5x13	6954	52	4198973	Union 1/4"	RACCORDO 2090 1/4" MFM
21	3001585	Flange For Velve 3001583	FLANGIA X VALVOLA 3001583		53	4196481	Lubricator	LUBRIFIC.1/4" GRIGIO (PLAST.)
22	4299000	O-Ring 9,8x3,85	ANELLO OR 9,8x3,85		54	4198883	Quick union 1/4"	RACCORDO S6500 1/4"-8 S.RAPIDO
23	3001849	Gt Pneumatic Valve Shaft	ASTA X VALVOLA PNEU. GT TN		55	2012307	Lubricator+filter regulator	GR.LUBRIF.+F.R. NEW TYPE
24	3001584	Spacer For Valve 3001583	DISTANZIALE X VALVOLA 3001583		56	2012960	Air intake unit	GR.INGR.ARIA CE SMTG SERIE80
25	3001583	Valve Distribution	VALVOLA DISTRIB.-SENZA CHIAVET		57	4399946	Screw 8x16	VITE TE 8x16 8.8
26	4198954	Quick Union 6510 1/8" - 8	RACCORDO POC 1/8"-8 S.R.6510		58	2019191	Pneum. Control Unit Gt	CENTR. PNEUM. COATS 9024E GAE
27	4199161	Plug	TAPPO MASCHIO 2611 1/8"		59	4299354	Pushbutton Relief	PULSANTE DI SCARICO
28	4199888	T-Union	RACCORDO "T" 1/8"-8/6 A.112		60	4399256	Washer 1/4" D.13x19x1,5	ROND. RAME 1/4" (13x19x1,5)
29	4199098	Quick Union 1/8" 6-4	RACCORDO S6500 1/8" 6-4 S.RAPID		61	3015111	Distribution Frame	RIPARTITORE 4 VIE F1/4"
30	3010062	Hose Rilsan D.8x6 L=1300	TUBO RILSAN BIANCO 8x6 L=1300		62	4396593	Screw 4x40	VITE TCEI M 4x40 PF 8.8
31	2017491	Valve Pneumatic 1"	VALVOLA PNEUM. 1"		63	2019171	Air tank	GR.SERBARIA18Lt.PREMONTASME90
32	2017906	Quick union	GR.RACC. INNESTO RAP. + OR					

64	6615108	GT front sheet	LAMIERA ANTER. GT-NERO BUCC.	83	8110325	1/4" NPT Male Run Tee	RACCORDO 1/4" NPT
65	4398723	Screw M6x12	VITE TE M6x12			GAE code 4194057	
66	4398945	Self-tapping screw 4x12,6	VITE AUTOPERF. TCB 4x12,6 ZNT	84	8109466	Valve-Piloted	VALVOLA PILOTATA
67	8183612	Union, Manifold	RIDUZIONE 183612 X COATS			GAE code 4194061	
		GAE code 4197408		85	8111255	Spl Tee=1/4 NPT x 3/8 x 1/4 Tube	RACCORDO 1/4" NPT x3/8" x1/4"
68	8111186	Pressure Limiter Assembly	GRUPPO LIMITATORE DI PRESSIONE			GAE code 4194058	
		GAE code 2008887		86	4196354	Valve 400 1/4" F-F	VALVOLA MVS 2901 DF 1/4"
69	3008992	Pressure Regulator Bracket	SUPPORTO REGOL. PRESS.-BRUNITO	87	4199987	Connection	ATTACCO RESCA ART.017 D.8
70	4399300	Screw M6 x 12 8.8	VITE TCEI M 6x12 8.8 5931	88	4198883	Quick Union 6500 1/4" - 8	RACCORDO S6500 1/4"-8 S.RAPIDO
71	4399998	Washer M6 (6,4 x 12 x 1,6)	RONDELLA 6 (6,4x12x1,6)ZNT6592	89	2009509	Unidirectional valve group	GRUPPO VALVOLA UNIDIREZ
72	4399299	Screw 6 x 30 8.8	VITE TCEI M 6x30 8.8 5931	90	4198853	Unidirectional valve 1/4"	VALVOLA UNIDIREZIONALE 1/4"
73	8109468	Pressure Repeater	RIPETITORE DI PRESSIONE	91	4295590	O ring D.12,42x1,78	ANELLO OR 2050 D.12,42x1,78
		GAE code 4194062		92	4199026	Connection	ATTACCO RESCA 2P 1/4 8
74	8110497	Fitting-90 Deg. Male Elbow	RACCORDO A GOMITO	93	3017494	U-Fork	FORCELLA A "U"
		GAE code 4194053		94	4399903	Washer 4 (4,5x12x1,5)	RONDELLA 4 (4,5x12x1,5)
75	8182038	Nylon Tube 1/4" OD x 10" Lg.	TUBO RILSAN 1/4"	95	2019192	Air tank	GR.SERBATOIO ARIA ASME 90°
		GAE code 3019253		96	4294322	O-ring 3112 D. 28,24x2,62	ANELLO OR 3112 D. 28,24x2,62
76	8103649	Ø1/4" x 12" Hose	TUBO RILSAN 1/4"x12"				
		GAE code 3019252					
77	8182035	Male St Fit. 1/8 NPT x 1/4 Tube	RACCORDO F1/8 x 1/4"				
		GAE code 4194055					
78	8111083	Regulator	REGOLATORE DI PRESSIONE				
		GAE code 4194060					
79	8109472	1/8" Inline Filter	RACCORDO 1/8"				
		GAE code 4194054					
80	8110496	Volumn Chamber	CAMERA VOLUMETRICA				
		GAE code 4194063					
81	8109471	1/8" Brass Hex Nipple	RACCORDO 1/8"				
		GAE code 4194059					
82	8101428	Hose Clamp-1/4 ID Hose	FASCETTA 1/4"				
		GAE code 4197390					

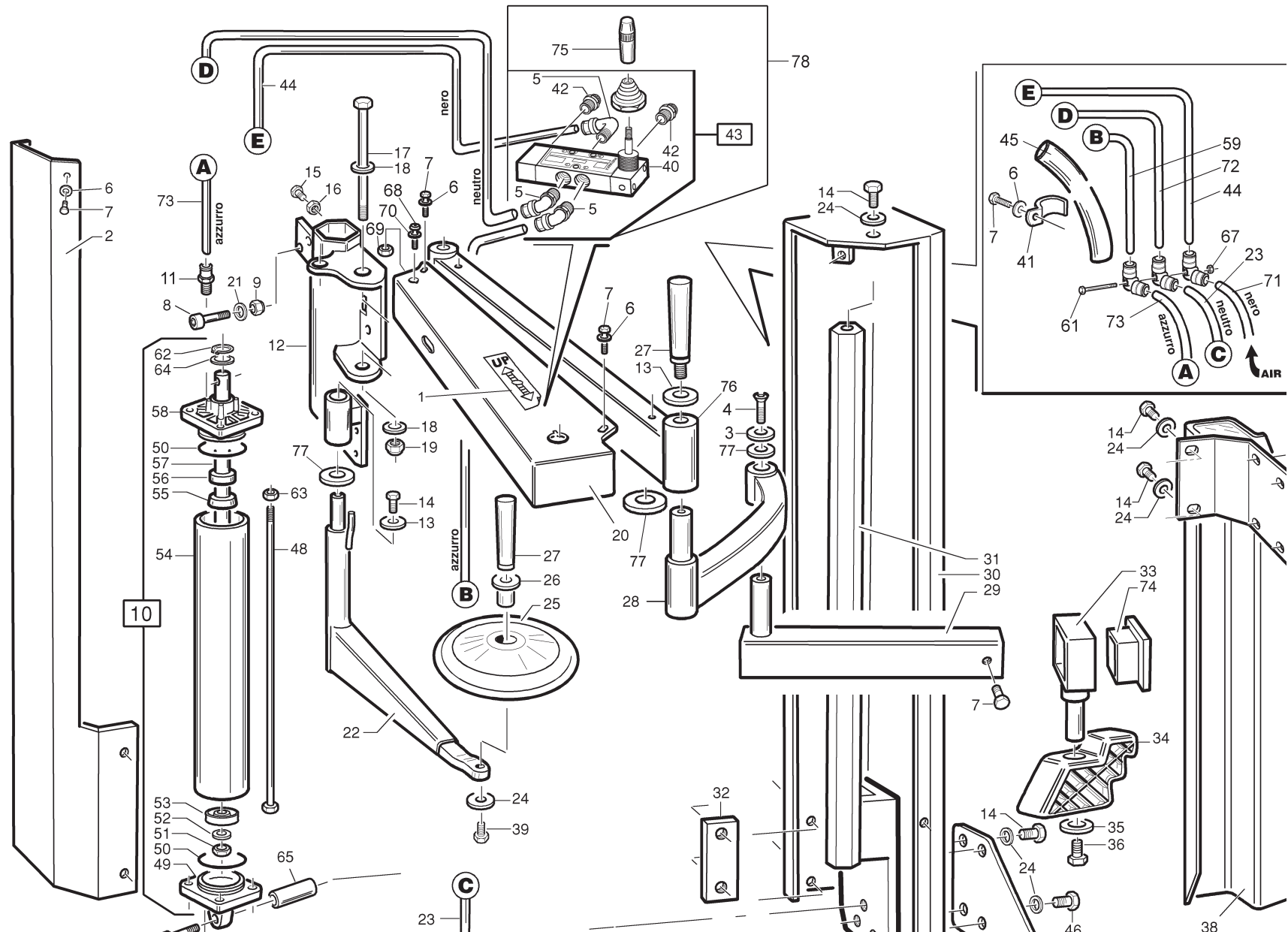

1	3008944	DECAL	DECALCO FRECCIA + UP	38	6606887	COLONNE BASE P.A.2	COLONNA BASE P.A.2
2	6608820	P.A.3 COVER	COPERCHIO P.A.3-	39	4399228	SCREW TE 10x25 8.8	VITE TE 10x25 8.8 5739
3	3009088	WASHER D. 10x45x4	RONDELLA D.10x45x4 -SVASATA	40	4198285	5-WAYS VALVE	VALVOLA 5 VIE 228-53-31-9-1/2
4	4399120	SCREW 10x20 10.9	VITE TSPEI M10x20 10.9 5933	41	4295214	STEEL HOOK D.16	GAFFETTA IN ACCIAIO D.16
5	4198993	UNION 6512 1/8" - 6	RACCORDO 6512 1/8"-6	42	4199610	SILENCER 1/8"	SILENZIATORE 1 SFE 1/8"
6	4399998	WASHER 6 (6,4x12x1,6)	RONDELLA 6 (6,4x12x1,6)ZNT6592	43	2006996	VALVE UNIT	GR.VALVOLA HELP-PRESS ARM
7	4398723	SCREW 6x12 8.8	VITE TE 6x12 8.8 5739	44	3015980	RILSAN HOSE D.6x4 L=1050	TUBO RILSAN 6X4 L=1050
8	3000599	PIN L=50	PERNO X CROC. M12 L=50 TCEI	45	3012448	PVC SHEATH 18x20 L=750	GUAINA PVC 18x20 L=900 mm
9	4399865	SELF-LOCKING NUT M12	DADO AUTOBL.M12 BASSO.6S. 7474	46	4399786	SCREW M10x30 8.8	VITE TE 10x30 8.8 5739
10	2008857	CYLINDER UNIT	GR.CILINDRO P.A.3 INT.	47	4399969	NUT M10	DADO M10 6S ALTO ZNT 5587
11	4198993	QUICK UNION 1/8"	RACCORDO 6512 1/8"-6	48	3008860	STUD BOLT M8x1,25x437	VITE PRIGION. M8x1,25x437 ZNT
12	6608820	ARM COVER	COPERCHIO P.A.3-NERO BUCC.	49	3002293	BACK FLANGE	FLANGIA POSTER. CIL. AUT.
13	3002311	WASHER D.10x45x4	RONDELLA D.10x45x4 -ZINCATA	50	4298822	O-RING D.68,26x3,53	ANELLO OR 842 D.68,26x3,53
14	4399966	SCREW M10x20 - 8.8	VITE TE 10x20 8.8 5739	51	4399934	NUT M12	DADO M12 METALTRIBLOK SPEC.
15	4398901	SCREW 10x20	VITE OTTONE TE M10x20 5739	52	4398753	WASHER D.12,5x30x3	RONDELLA 12,5x30x3 ZNT.
16	4399967	NUT M10	DADO M10 6S BASSO ZNT 5589	53	4198856	PISTON D.75	PISTONE MONOBLOCCO D.75
17	4395502	SCREW TE 16x160 8.8	VITE TE 16x160 8.8 P.F. 5737	54	3008858	CYLINDER LINER L=405	CAMICIA CIL. P.A.3 L=405
18	4399828	WASHER 16 (17x30x3)	RONDELLA 16 (17x30x3) ZNT 6592	55	3199601	OIL SCRAPER	RASCH.BID. NSW 20-30-6 XNU01
19	4399963	SELF-LOCKING NUT M16	DADO AUTOBL.M16 BASSO.6S. 7474	56	4298823	GUIDE IN NYLON	NASTRO DI GUIDA ASTA CILINDRO
20	6615928	ARM FRAME	CARENATURA BRACCIO 1.	57	3008859	CYLINDER SHAFT D.20 L=458	ASTA CIL. P.A.3 D.20 L=458
21	4399981	WASHER 12 (13x24x2,5)	RONDELLA 12 (13x24x2,5)	58	3002294	FRONT FLANGE	FLANGIA ANTER. CIL. AUT.
22	6607545	BEAD BREAKING DISK ARM L=425	BRACCIO DISC.ST.PA2 L425-NERO	59	3015947	HOSE 6x4 L=1050	TUBO ELASTOLAN 6X4 L=1050 AZZURRO
23	3015950	RILSAN HOSE D.6x4 L=580	TUBO ELASTOLAN 6X4 L=580 NEUTRO	60	3014450	HOSE 6x4 L=1500	TUBO ELASTOLAN 6X4 L=1500
24	4399378	WASHER D.10 (10,5x21x2)	RONDELLA 10 (10,5x21x2)ZNT6592				
25	3006886	BEAD BREAKING DISK	DISCO STALLONATORE				
26	3006862	DISK UPPER PIN	PERNO SUP.DISCO ST.BRUNITO				
27	4297980	HANDLE WITH PIN M10x20	IMPUGNATURA CON PERNO M10X20				
28	6613004	ARM 2 P.A.3	BRACCIO 2 P.A.3				
29	2108983	ARM 3 P.A.3	BRACCIO 3 P.A.3-ZNT B.				
30	6608819	P.A.3 BASE	PALO VERT. P.A.3				
31	2108818	VERTICAL ARM P.A.3	PALO VERT. P.A.3				
32	3007781	FIXING PLATE	PIASTRA FISS.COL./BASAM.-BRUN.				
33	2115062	ARM 3 SLIDE	SCORR.BRACCIO 3 P.A.4.				
34	3008404	BEAD PRESSING TOOL 50x90x110	PREMITAL.50x90x110 PVC GRIGIO				
35	4399863	WASHER 8 (9x24x2)	RONDELLA 8 (9x24x2) ZNT 6593				
36	4399298	SCREW M 8x16 8.8	VITE TCEI M 8x16 8.8 5931				
37	6606888	SUPPORT	STAFFA P.A.2				

61	4395146	SCREW 3x45	VITE TCEI 3x45
62	3199599	SEEGER RING D.30	ANELLO SEEGER I D.30 JV
63	4397678	FLANGE NUT M8	DADO FLANGIATO M8 ZNT DIN 6923
64	4398146	SHIM D.24x30x0,3	RASAMENTO D.24x30x0,3
65	3007864	SPACER 12x18x45	DISTANZ. 12x18x45 -BRUNIT.
66	4399398	SCREW 12x85 8.8	VITE TE 12x85 8.8 P.F. 5737
67	4399895	SELF-LOCKING NUT M4	DADO AUTOBL.M 4 BASSO
68	4396635	SCREW 10x20	VITE TBEI 10x20
69	4399967	NUT M10	DADO M10 6S BASSO
70	4399378	WASHER D.10 (10,5x21x2)	RONDELLA 10 (10,5x21x2)
71	3015952	HOSE 6x4 L=2000	TUBO ELASTOLAN 6X4 L=2000
72	3015979	HOSE 6x4 L=1050	TUBO ELASTOLAN 6X4 L=1050 NEUTRO
73	3015949	HOSE 6x4 L=90	TUBO ELASTOLAN 6X4 L=90 AZZURRO
74	3013112	ARM END PART	TERMINALE BRACCETTO P.A.
75	3010284	KNOB D.14X45 M5	POMOLO D.14x45 FORO M5
76	6609589	ARM	BRACCIO 1 P.A. A.T.-NERO B.
77	4395462	COMPENSATION RING D.35X42X0,5	RASAMENTO COMPENS. D.35X45X0,3
78	2019027	ASSEMBLY VALVE + KNOB FOR HELPER TOW	KIT VALVOLA HELP/PRESS + POMOLO

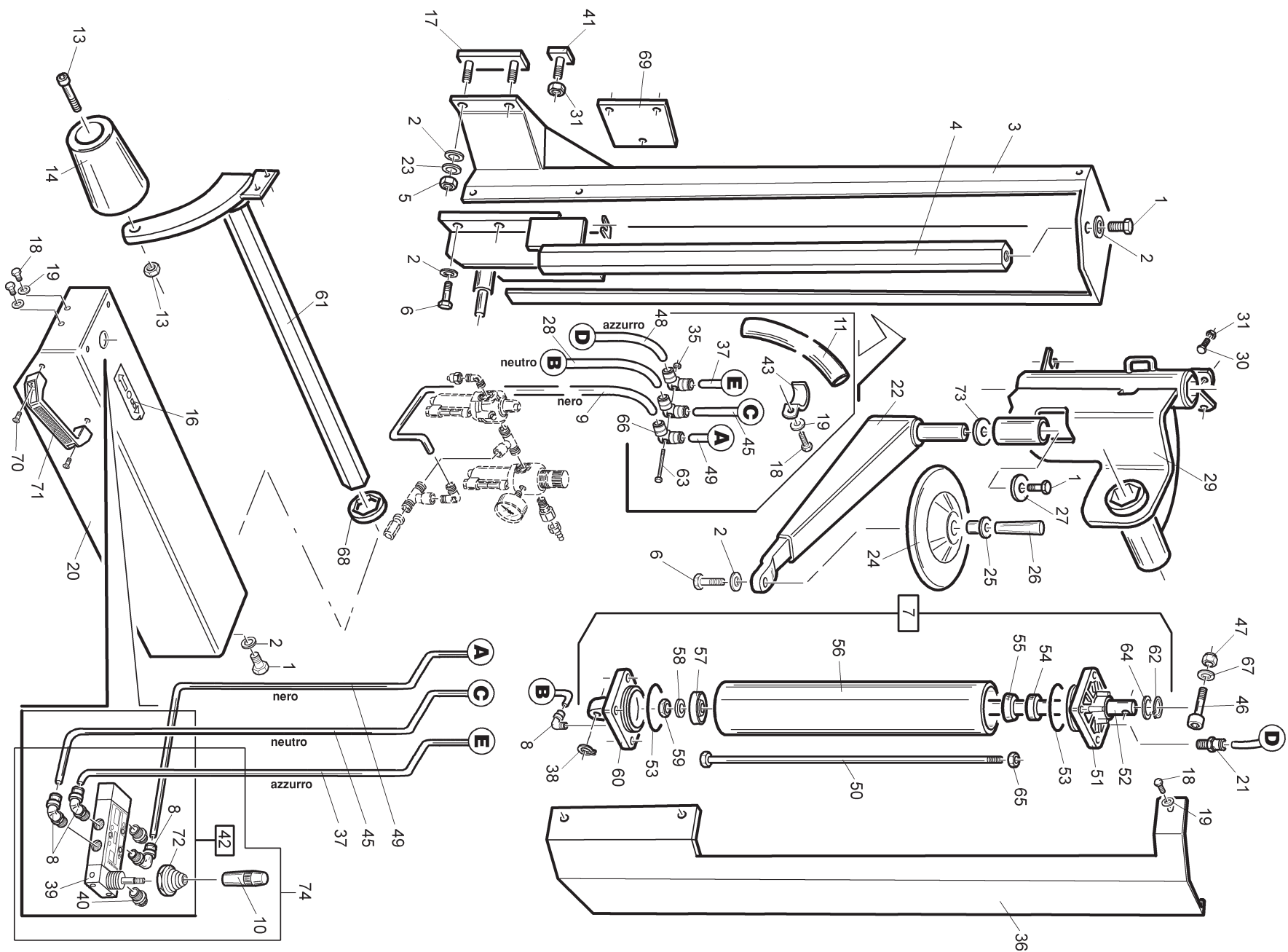

1	4399966	SCREW M10x20 - 8.8	VITE TE 10x20 8.8	5739	31	3006641	KEEP PLATE	SQUADRETTA LUBR. BIG - ZNT
2	4399378	WASHER D.10 (10,5x21x2)	RONDELLA 10 (10,5x21x2)ZNT6592		32	2110301	U BOLT	CAVALLOTTO FISS. H3 S113-BRUN.
3	2108816	HELP 4 BASE	BASAMENTO HELP 4-BLU 5015		33	6610304	SUPPORT	STAFFA SUPP. H4 S113-NERO
4	2108815	VERTICAL ARM HELP 4	PALO VERT. HELP 4		34	2010310	HELP ARM INSTALLATION KIT	KIT APPLIC. HELP4-NERO
5	4399969	NUT M10	DADO M10 6S ALTO ZNT	5587	35	4395145	SELF-LOCKING NUT M3	DADO AUTOBL.M 3 BASSO.6S.
6	4399786	SCREW M10x30 8.8	VITE TE 10x30 8.8	5739	36	2108817	HELP 4 COVER	COPERCHIO HELP 4-BLU 5015
7	2008332	HELP 3 CYLINDER UNIT	GR.CILINDRO HELP 3 INT.		37	3015948	HOSE 6x4 L=1500	TUBO ELASTOLAN 6X4 L=1500
8	4198618	UNION 1/8"	RACCORDO 6522 1/8"-6		38	4399864	SEEGER RING D.12	ANELLO SEEGER E D.12 7435
9	3015952	HOSE 6x4 L=2000	TUBO ELASTOLAN 6X4 L=2000		39	4198285	5-WAYS VALVE	VALVOLA 5 VIE 228-53-31-9-1/2
10	3010284	KNOB D.14X45 M5	POMOLO D.14x45 FORO M5 ZNT		40	4199610	SILENCER 1/8"	SILENZIATORE 1 SFE 1/8"
11	3009505	PVC SHEATH 18x20 L=860	GUAINA PVC 18x20 L=860 mm		41	2108784	ANTIROTATION SCREW H.3	VITE ANTIROTAZIONE H.3-BRUN.
12	4397454	SCREW 20x90 8.8	VITE TCEI M20x90 8.8	5931	42	2006996	VALVE UNIT	GR.VALVOLA HELP-PRESS ARM
13	4399810	NUT M20	DADO M20 6S BASSO ZNT	5589	43	4295214	STEEL HOOK D.16	GAFFETTA IN ACCIAIO D.16
14	3008433	BEAD BREAK. ROLLER D.102 L=120	RULLO ST.D.102 L120 PVC GRIGIO		44	3014451	HOSE 6x4 L=1100	TUBO ELASTOLAN 6X4 L=1100
15	6607115	HORIZONTAL ARM	BRACCIO OR.ES.36		45	3016150	HOSE 6x4 L=1500	TUBO ELASTOLAN 6X4 L=1500
16	3008944	DECAL	DECALCO FRECCIA + UP		46	3000599	PIN L=50	PERNO X CROC. M12 L=50 TCEI
17	2108782	H.3 FASTENING U-BOLT	CAVALLOTTO FISSAGGIO H.3-BRUN.		47	4399865	SELF-LOCKING NUT M12	DADO AUTOBL.M12 BASSO.6S. 7474
18	4398723	SCREW 6x12 8.8	VITE TE 6x12 8.8	5739	48	3015949	HOSE 6x4 L=90	TUBO ELASTOLAN 6X4 L=90
19	4399998	WASHER 6 (6,4x12x1,6)	RONDELLA 6 (6,4x12x1,6)ZNT6592		49	3014450	HOSE 6x4 L=1500	TUBO ELASTOLAN 6X4 L=1500
20	2106853	HORIZONTAL ARM COVER	COPERCHIO B.O. HELP 3-BLU 5015		50	3008334	STUD BOLT 8x1,25x522	VITE PRIGION. M8x1,25x522 ZNT
21	4198993	QUICK UNION 1/8"	RACCORDO 6512 1/8"-6 S.R.(DIRITTO+OR)		51	3015024	FRONT FLANGE	FLANGIA ANTER. CIL. AUT.
22	6607546	BEAD BREAKING DISK ARM L=605	BRACCIO DISC.ST. H3 L605-NERO		52	3006649	CYLINDER SHAFT L=559	ASTA CIL. HELP 2/3 L=559
23	4398662	GROWER WASHER D.10	ROND.GROWER D.10 ZNT	1751	53	4298822	O-RING D.68,26x3,53	ANELLO OR 842 D.68,26x3,53
24	3006886	BEAD BREAKING DISK	DISCO STALLONATORE		54	4299168	O-RING 20,29x2,62	ANELLO OR 3081 D.20,29x2,62
25	3006862	DISK UPPER PIN	PERNO SUP.DISCO ST.BRUNITO		55	3199601	OIL SCRAPER	RASCH.BID. NSW 20-30-6 XNU01
26	2012683	HANDLE+SCREW	GR.IMPUGNATURA+VITE STEI M10		56	3008333	CYLINDER LINER H.3 L=490	CAMICIA CIL. HELP 3 L=490
27	3002311	WASHER D.10x45x4	RONDELLA D.10x45x4 -ZINCATA		57	4198856	PISTON D.75	PISTONE MONOBLOCCO TDUOP D.75
28	3015945	HOSE 6x4 L=1500	TUBO ELASTOLAN 6X4 L=1500		58	4398753	WASHER D.12,5x30x3	RONDELLA 12,5x30x3 ZNT.
29	6615666	HELP 3 SLIDE	SCORREVOLE HELP 4-NERO B		59	4399865	SELF-LOCKING NUT M12	DADO AUTOBL.M12 BASSO.
30	4398901	SCREW 10x20	VITE OTTONE TE M10x20	5739				

60	3015023	BACK FLANGE	FLANGIA POSTER. CIL. AUT.
61	6608962	HORIZONTAL ARM	BRACCIO OR.E.36 HELP 231-NERO
62	3199599	SEEGER RING D.30	ANELLO SEEGER I D.30 JV
63	4395146	SCREW 3x45	VITE TCEI 3x45
64	4398146	SHIM D.24x30x0,3	RASAMENTO D.24x30x0,3
65	4399976	NUT M8	DADO M 8 6S ZNT 5588
66	4196333	UNION	RACCORDO 6550 6 SANG-A(+ANELLO)
67	4399981	WASHER 12 (13x24x2,5)	RONDELLA 12 (13x24x2,5)ZNT6592
68	3002601	MOUNTING HEAD SHOCK ABSORBER	AMMORTIZ. TORRETTA ES.41
69	3009675	FIXING PLATE H.4	PIASTRA FISSAGGIO H.4 -BRUNITO
70	4297851	HANDLE	MANIGLIA A PONTE ABS PICCOLA
71	4398672	SCREW 6x16 10.9	VITE TSPEI M 6x16 10.9 5933
72	4297978	VALVE COVER	CUFFIA X VALVOLA 5 VIE
73	4395462	COMPENSATION RING D.35X42X0,5	RASAMENTO COMPENS. D.35X45X0,3
74	2019027	ASSEMBLY VALVE + KNOB FOR HELPER TOW	KIT VALVOLA HELP/PRESS + POMOLO



HENNESSY **INDUSTRIES, INC.**

1601 J.P. Hennessy Drive, LaVergne, TN USA 37086-3565 615/641-7533 800/688-6359

HENNESSY INDUSTRIES INC. Manufacturer of AMMCO®, COATS® and BADA® Automotive Service Equipment Tools.