

COATS®

RC-50M

Rim Clamp® Tire Changer

For servicing motorcycle and ATV tire/wheel assemblies

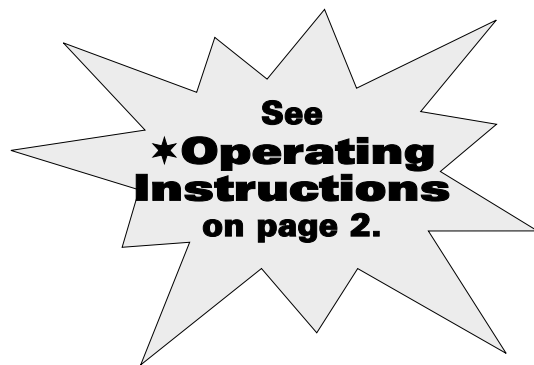
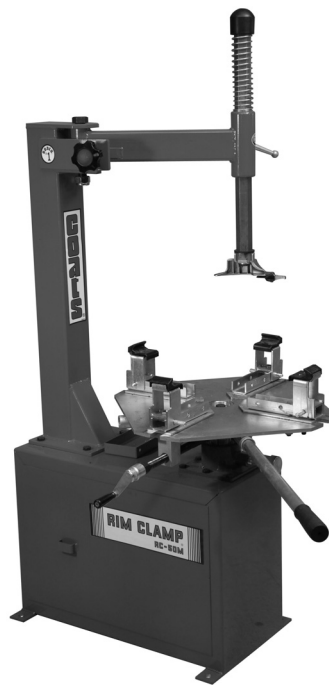

Installation Instructions
Operating Instructions
Safety Instructions
Maintenance Instructions
with Parts List

READ these instructions before placing unit in service KEEP these and other materials delivered with the unit in a binder near the machine for ease of reference by supervisors and operators.

HENNESSY INDUSTRIES, INC.

1601 J. P. Hennessy Drive, LaVergne, TN USA 37086-3565 615/641-7533 800/688-6359

HENNESSY INDUSTRIES INC. Manufacturer of AMMCO®, COATS® and BADA® Automotive Service Equipment and Tools.

Manual Part No.: 85000625 00

Revision: 05/07

Table of Contents

Safety Instructionsiii
Owner's Responsibility	iii
Operator Protective Equipment	iii
Definitions of Hazard Levels	iii
Safety Notices and Decals	iv
Principle Operating Partsiv - 1
Know Your Unit	iv - 1
Operating Instructions2 - 7
Bead Loosening and Demounting	2 - 5
Mounting	6 - 7
Inflation7
Maintenance Instructions8
Installation Instructions9
Location	9
Floor Mounting	9
Assembly Instructions	9
Parts List10

Safety Instructions

Owner's Responsibility

To maintain machine and user safety, the responsibility of the owner is to read and follow these instructions:

- Follow all installation instructions.
- Make sure installation conforms to all applicable Local, State, and Federal Codes, Rules, and Regulations; such as State and Federal OSHA Regulations and Electrical Codes.
- Carefully check the unit for correct initial function.
- Read and follow the safety instructions. Keep them readily available for machine operators.
- Make certain all operators are properly trained, know how to safely and correctly operate the unit, and are properly supervised.
- Allow unit operation only with all parts in place and operating safely.
- Carefully inspect the unit on a regular basis and perform all maintenance as required.
- Service and maintain the unit only with authorized or approved replacement parts.
- Keep all instructions permanently with the unit and all decals/labels/notices on the unit clean and visible.
- Do not override safety features.

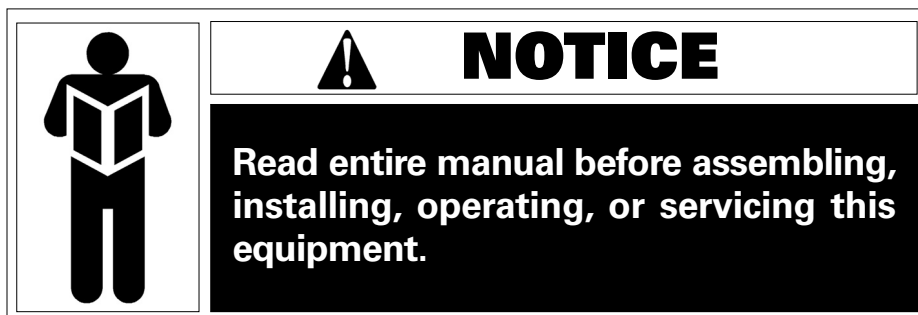

Operator Protective Equipment

Personal protective equipment helps make tire servicing safer. However, equipment does not take the place of safe operating practices. Always wear durable work clothing during tire service activity. Loose fitting clothing should be avoided. Tight fitting leather gloves are recommended to protect operator's hands when handling worn tires and wheels. Sturdy leather work shoes with steel toes and oil resistant soles should be used by tire service personnel to help prevent injury in typical shop activities. Eye protection is essential during tire service activity. Safety glasses with side shields, goggles, or face shields are acceptable. Back belts provide support during lifting activities and are also helpful in providing operator protection. Consideration should also be given to the use of hearing protection if tire service activity is performed in an enclosed area, or if noise levels are high.

Definitions of Hazard Levels

Identify the hazard levels used in this manual with the following definitions and signal words:

DANGER

Watch for this symbol:



It Means: Immediate hazards, which will result in severe personal injury or death.

WARNING

Watch for this symbol:



It Means: Hazards or unsafe practices, which could result in severe personal injury or death.

CAUTION

Watch for this symbol:



It Means: Hazards or unsafe practices, which may result in minor personal injury or product or property damage.



Watch for this symbol! It means BE ALERT! Your safety, or the safety of others, is involved!

Safety Notices and Decals



Failure to follow danger, warning, and caution instructions may lead to serious personal injury or death to operator or bystander or damage to property. Do not operate this machine until you read and understand all the dangers, warnings and cautions in this manual. For additional copies of either, or further information, contact:

Hennessy Industries, Inc.

1601 J.P. Hennessy Drive
LaVergne, TN 37086-3565
(615) 641-7533 or (800) 688-6359
www.ammcoats.com

For additional information contact:

Rubber Manufacturers Association

1400 K Street N.W.
Washington, DC 20005
(202) 682-4800

Tire Guides, Inc.

The Tire Information Center
1101-6 South Rogers Circle
Boca Raton, FL 33487-2795
(561) 997-9229
www.tireguides.com

Principal Operating Parts

Know Your Unit

Compare this illustration with the unit before placing it into service. Maximum performance and safety will be obtained only when all persons using the unit are fully trained in its parts and operation. Each user should learn the function and location, of all controls.

Prevent accidents and injuries by ensuring the unit is properly installed, operated and maintained.

- A Vertical Slide Locking Handle** — Locks and unlocks vertical slide and sets correct vertical position to maintain head/wheel clearance.
- B Swing Arm Adjustment Knob** — Adjusts swing arm/vertical slide assembly for proper horizontal positioning of duckhead®.
- C Tower** — Support for horizontal swing arm and vertical slide.
- D Table Top Rotating Handle Receiver** — Insert table top rotating handle into this receiver (4 receivers / 90 degrees apart).
- F Clamping Screw** — Use to open or close rim clamps.
- G Table Top Locking Knob** — Locks and unlocks the table top position. Use to prevent the table top from rotating.
- H Table Top Rotating Handle** — Use for extra leverage when rotating table top during tire removal.
- J Table Top** — Rotating platform for tire changing.
- K Three Position Motorcycle Clamps** — Holds wheel to table top for tire changing (4 clamps / 90 degrees apart).
- L Motorcycle DuckHead®** — Mounts and demounts tire from wheel.
- M Bead Loosener (Optional)** — Use to loosen bead of tires.
- O Mounting Tabs** — Use to adjust bead loosener position to match tire/rim combination.
- P Mounting Slots** — Attaches bead loosener to tire changer.

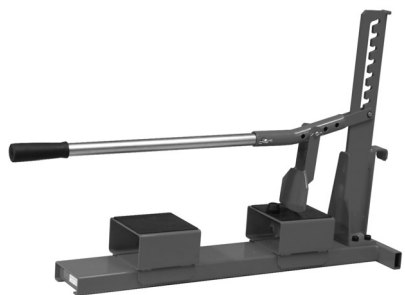
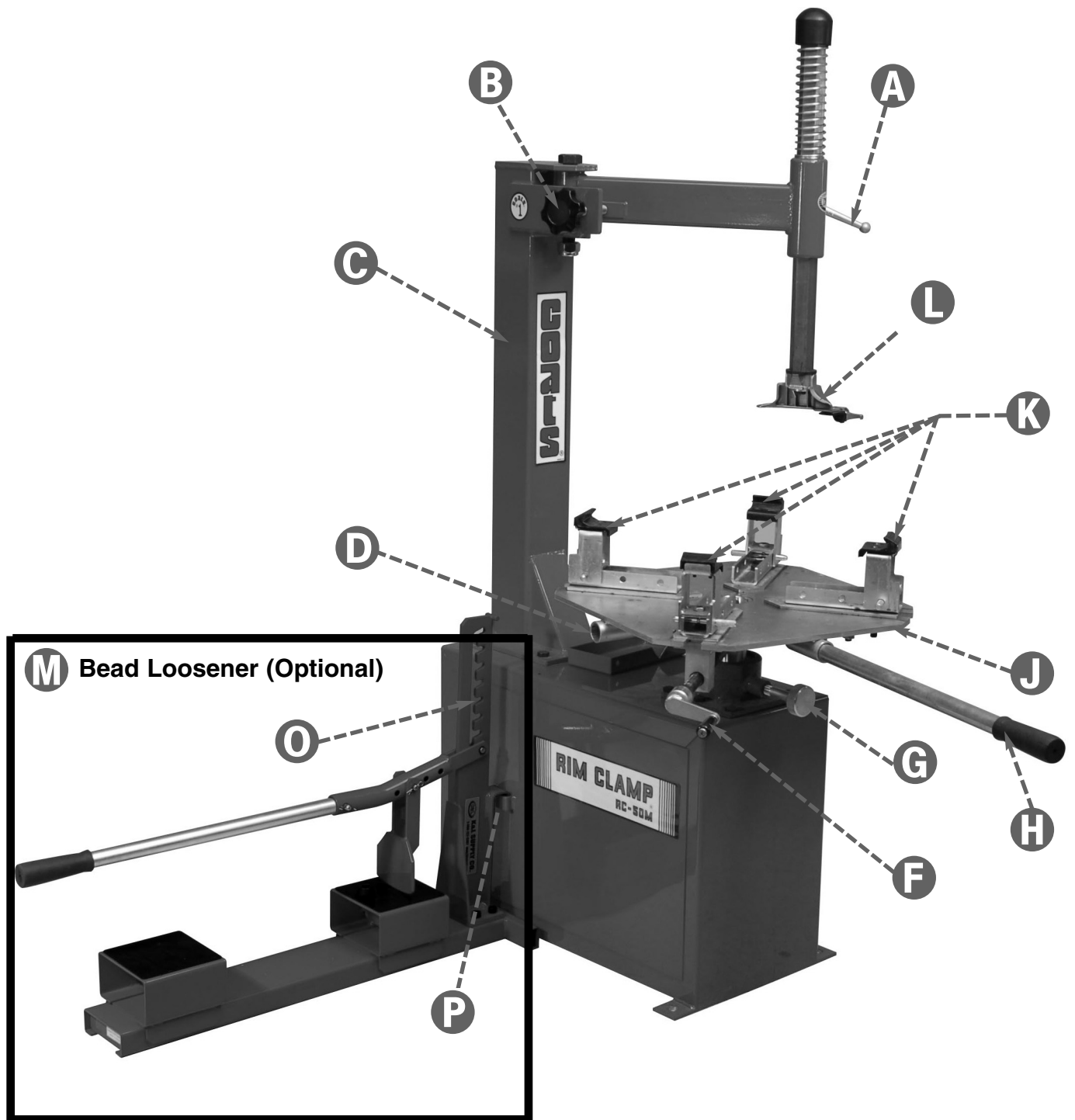

**Bead Loosener shown separately for clarity
Part Number 85000503**

Operating Instructions

This unit must be properly operated and properly maintained to help avoid accidents that could damage the unit and injure the operator or bystanders. This section of the Operating Instructions manual reviews basic operations and use of controls. These instructions should be reviewed with all employees before they are allowed to work with the machine. Keep these instructions near the machine for easy reference.

Bead Loosening and Demounting



This machine may operate differently from machines you have previously operated. Practice with a regular steel wheel and tire combination to familiarize yourself with the machine's operation and function.

Remember to remove all weights from both sides of the wheel. Weights left on backside of wheel may cause the wheel to be clamped unlevelled. This may result in the combination duckhead® contacting the rim causing scratches. On alloy wheels, always rotate the wheel one turn after setting the duckhead to insure proper wheel chucking.

Note: Always review with the owner any nicks and scratches on expensive wheel and tire combinations prior to servicing.

1. Deflate the tire completely by removing the valve core from the valve stem (figure 1). Be cautious and do not smoke as a *flammable gas could have been introduced into the tire at some time.*



Figure 1 - Remove Valve Core to Deflate Tire



Loosening the beads on a partially or fully inflated tire is unsafe and causes excess movement and friction against the bumper pads and excessive wear on pivots. Deflate the tire completely to prolong the life of your machine.

ATV Note: It may be necessary on ATV wheels to leave 3-6 PSI in some of these wheels to facilitate bead loosening. Even after loosening one bead; it may be necessary to reinflate to 5 PSI to loosen the opposite bead.

Note: Always loosen the bead on the narrow side of the wheel's drop center first (motorcycle wheels may not have a narrow or long side, and some ATV wheels may not bolt together). See figure 4 for more information on the drop center.

Remember: The clamps on the table top may extend beyond the table top itself. To avoid damaging the clamps, move them to their full inward position before positioning a tire for bead loosening.

Note: Use extra care in positioning the bead loosener shoe on larger wheels/tires, and on alloy wheels. Make sure the shoe rests next to but not on the rim, and not on the tire sidewall.

2. If using the optional bead loosener, lift bead loosener shoe away from the machine. Adjust the blocks so that the rim rests on top of them. Lay wheel into position. Position the bead loosener shoe against the tire next to, but not on, the rim. Depress the bead loosener arm to loosen the bead. It may be necessary to loosen the bead in multiple locations around the tire (figure 2).



Figure 2 - Position Tire on Bead Loosener Shoe

3. Turn the wheel around and repeat loosening procedure on the other side of the wheel. This should be the long side of the drop center.

Tip: It will be easier to clamp the wheel to the table top if the lower bead is loosened last.

4. Apply tire manufacturer's approved rubber lubricant liberally to entire circumference of both tire beads after loosening (figure 3).

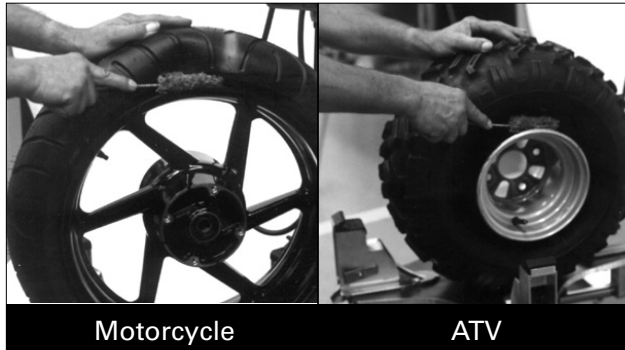

Figure 3 - Apply Rubber Lubricant to Tire Beads.

5. Next, observe the rim size from the tire, i.e. 15, 16, 17, etc. Turn the clamping screw to move the clamps in the proper position (slightly wider than the rim bead). It may be necessary to relocate the clamps on the clamp carriers. Be sure each clamp is in the same position before prelocating the clamps.

6. Determine the mounting side of the wheel. The mounting side is the narrow side of the drop center (tire removed in figure 4 for clarity).

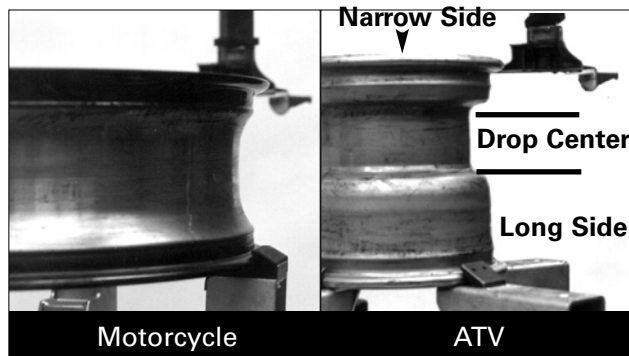

Figure 4 - Determining Mounting Side of Wheel (note that many motorcycle rims are symmetrical).

7. Using the tabletop locking knob (see letter G, pages iv and v), lock the tabletop in place. This will make mounting the tire/wheel assembly easier and more positive. The tabletop has locking holes 90-degrees apart that the knob engages; it is not friction lock. Place tire/wheel assembly on table top with mounting side up (figure 5). Rotate the clamping screw clockwise to move the clamps inward or crank counterclockwise to move the clamps outward. Clamp motorcycle and ATV wheels from the outside (clamps push inward against the outside rim edge). Place rim flange into rear clamp and slowly move the other

clamps inward until they contact the rim. Observe closely to prevent tire/wheel damage. If clamps are properly positioned and the tire/wheel assembly is secure, loosen the tabletop locking knob and proceed.



Figure 5 - Place Tire/Wheel Assembly on Table Top

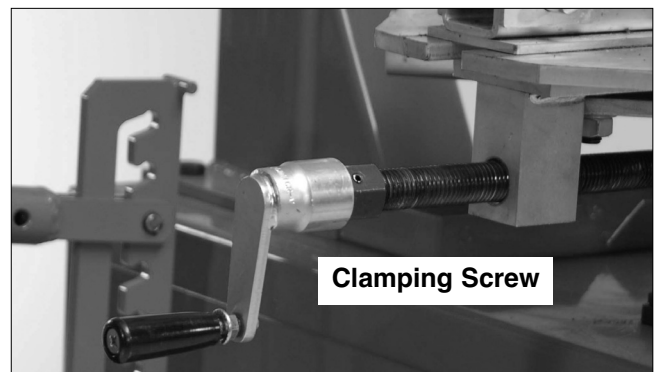

Figure 6 - Rotate Clamping Screw to Move Clamps Into Position

8. Move the swing arm into position. Pull the locking handle forward to release the slide. Push down on the top of the vertical slide to move the demount head into contact with the rim edge. Push the locking handle back to lock the slide into place. As the slide is locked, the mount/demount head will move upward approximately 1/8-inch from the rim edge.



Note: On plastic duckheads, the upward movement should be limited to 1/16-inch maximum.

Figure 7 - Position Mount/Demount Tool

9. The Duckhead® roller should be in contact with the rim edge. Turn the swing arm adjusting knob to move the head away from the rim 1/8 to 1/4-inch. On expensive and polished rims, it is recommended a plastic bootie (p/n 8183373) be used over the duckhead roller.

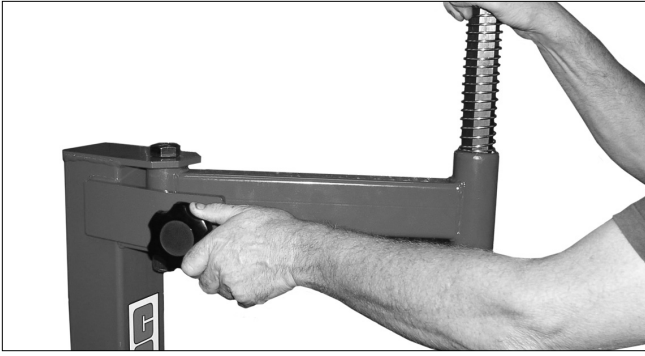

Figure 8 - Adjust Swing Arm to Position Head Roller

10. Check duckhead® positioning. Mount/demount head should be positioned with 1/8 to 3/16-inch clearance between the top of the rim edge and the bottom of the head (with plastic duckhead it is recommended the vertical clearance be limited to a maximum of 1/16-inch) and 1/8 to 1/4-inch clearance between rim edge and the head. This clearance will be maintained as long as locking handle and adjustment knob are not changed. The operator may swing the arm out of the way and back into place again without needing to reposition the head (when clamping a like set of wheels).

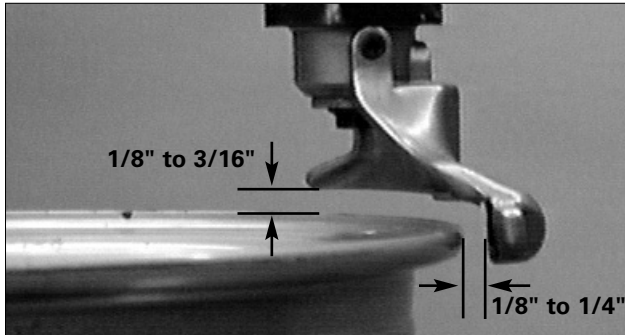

Figure 9 - Proper Mount/Demount Head Position

Important: The vertical tool clearance may change with machine use and should be inspected often. Failure to maintain the proper clearance may result in finish/painted/plated damage to the wheel rim.

11. Insert the smooth curved end of the bead lifting tool over the forward end of the demount head and below the top bead of the tire. Use your free hand to press down on the tire opposite the head to help with tool insertion.

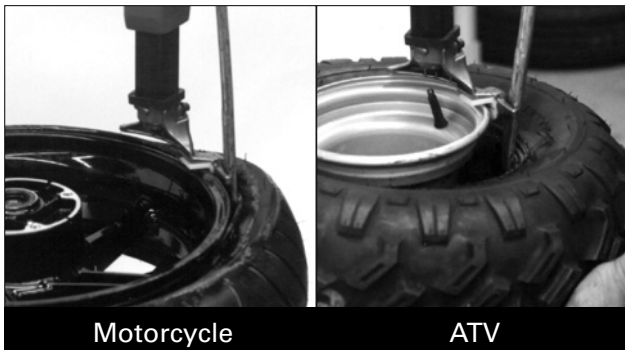

Figure 10 - Insert Bead Lifting Tool

12. Rotate the bead lifting tool down towards the wheel to lift the tire bead up and over the knob portion of the demount head. The lift tool may be removed if desired (figure 11).

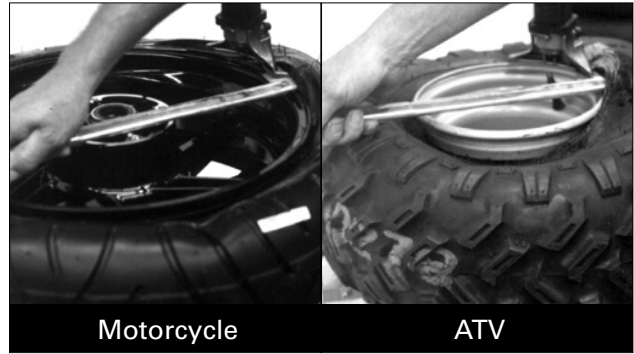

Figure 11 - Lift Bead Over Demount Head

13. Rotate the wheel clockwise. If additional leverage is needed, insert the table top rotating handle into the receiver and use the handle to rotate the table top. The demount head will guide the upper bead up and over the edge of the wheel.

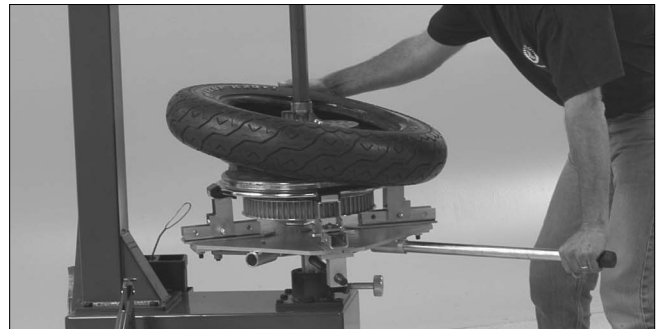

Figure 12 - Use Table Top Rotating Handle For Leverage

Note: Push down on the tire across from the demount head during table top rotation to utilize the drop center area of the wheel. This reduces the tensional force on the bead during demount.

14. Lift and hold the tire at an angle so that the lower bead is resting in the drop center directly across from the demount head, and is loose below the demount head. Insert the smooth curved end of the bead lifting tool down over the forward end of the mount/demount tool and below the lower bead. Lift the bead up and over the knob on the demount head (figure 13).

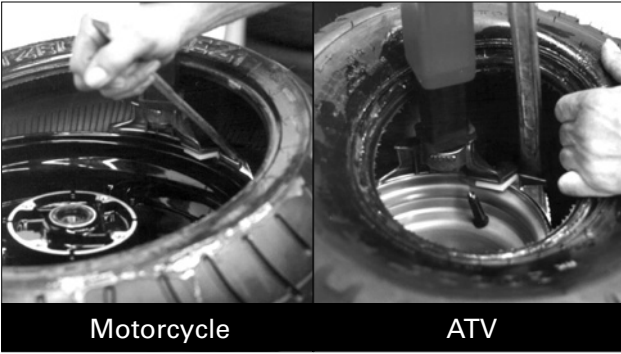

Figure 13 - Demounting Lower Bead

15. Turn the table top to rotate the wheel. The demount head will guide the bead up and over the edge of the wheel. Continue rotation until lower bead is demounted.

Note: With tube-type tires, demount the upper bead and remove the tube before demounting the lower bead.

Note: Normal table top rotation for demounting is clockwise.



At times during the mounting and demounting procedure, the bead lifting tool may encounter resistance or come under load. Keep one hand firmly on the tool to avoid possible tool disconnect. Turn the table top counterclockwise to back out of jam ups.



After successfully completing the demount process, proceed to MOUNTING.

Operator Protective Equipment

Always wear durable work clothing during tire service activity. Shop aprons or shop coats may also be worn, however, loose fitting clothing should be avoided. Tight fitting leather gloves are recommended to protect the operator's hands when handling worn tires and wheels. Sturdy leather work shoes with steel toes and oil resistant soles should be used by tire service personnel to help prevent injury in typical shop activities. Eye protection is essential during tire service activity. Safety glasses with side shields, goggles, or face shields are acceptable. Back belts provide support during lifting activities and are also helpful in providing operator protection.

Mounting

This information must be read and followed carefully to prevent accidents and injuries during mounting.



Check tire and wheel carefully before mounting. Make sure the tire bead diameter and wheel diameter match exactly. Consult the Rubber Manufacturer's Association for approved rim widths for tire sizes. Mismatched tires and wheels explode.



Never mount a tire and wheel handed to you by anyone without checking both tire and wheel for damage and compatibility. The problem of mis-matched tires/wheels is preventable. Be extra cautious of persons without knowledge of tire service. Keep bystanders out of service area; there is a risk that could result in injury.



Never mount a damaged tire. Never mount a tire on a rusty or damaged wheel. Damaged tires and/or wheels may explode.



If you damage the tire bead during mounting, STOP!, remove the tire and mark it as damaged. Do not mount a damaged tire.

1. Inspect the wheel closely for damage. Clean the wheel and remove any light corrosion or rubber residue (figure 14). Do not attempt to service heavily corroded wheels.

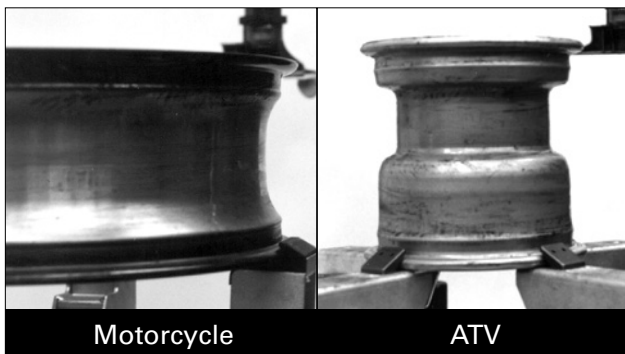

Figure 14 - Inspect and Clean the Wheel

2. Inspect tire for damage, paying close attention to the beads. Verify size match between tire and wheel.

3. Lubricate tire beads liberally with tire manufacturer approved lubricant (figure 15).



Figure 15 - Lubricate Beads

4. Place tire over wheel and move swing arm into position. Position the tire so that the lower bead is above the rear extension of the mount/demount head and below the front knob (figure 16).

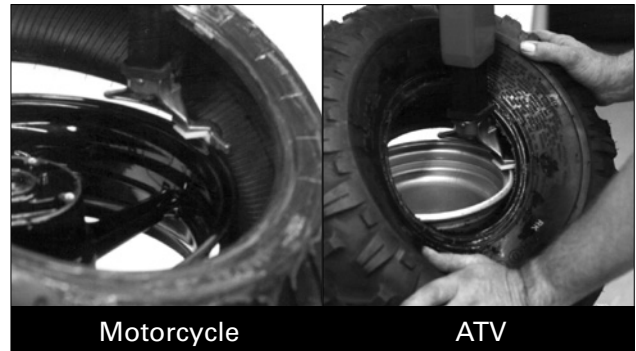

Figure 16 - Position Tire Against Mount/Demount Head

5. Turn the table top and rotate the wheel to mount the lower bead. Use the drop center of the wheel to reduce the tensional force on the bead by pressing down on the tire directly across from the mount head. Rotate table top until lower bead is fully mounted.

6. For top bead, rotate table top until the valve stem is 90 degrees forward of the mount head. Lift the upper bead up and over the rear of the mount head. With your left hand press down on the tire between the mount head and the valve stem to hold the tire in the drop center. Rotate the tire until the bead is mounted. Continue to press down on the tire during the remaining mounting process.



Do not force the tire onto the rim. Bead damage could result making the tire unsafe and/or creating the risk of injury.

Note: If table top rotation begins to jam, reverse the table top momentarily until the tire bead is again loose on the wheel. Reposition the mount head, make sure the bead is correctly positioned in the drop center of the wheel; then attempt mounting again.

Note: For low profile or stiff sidewall tires, it may be advantageous to use the bead lifting tool to initially hold the upper bead down in the drop center

Note: For tube type tires, mount the lower bead first, move swing arm out, install the tube, and then mount the upper bead.

When you have completed the mounting process, proceed to inflation.

Inflation



Do not inflate tire while wheel is clamped to the Table Top. Tire failure under pressure is hazardous. This tire changer Will Not Restrain Exploding Tires, rims or other related equipment. Inspect tire and wheel carefully for match, wear, damage, or defects before mounting. Always use approved tire bead lubricant during mounting and inflation.

Do not inflate tire while wheel is clamped to the table top. Remove tire and wheel assembly from machine to inflate. Use a remote controlled inflation device when inflating; to seat beads, use a small amount of air intermittently; never exceed the tire manufacturer's recommendation when inflating. If beads do not seat, remove air and relubricate beads. After tire is properly inflated secure bead locks were required.

ATV Tire Inflation: ATV tire inflation is unique in that the bead seat pressure allowed is more than the operating pressure. ALWAYS follow the tire manufacturer's information on inflation. This information can be printed on the sidewall, on the tire sticker, or from the manufacturer.

Maintenance Instructions

Read and follow all the maintenance instructions provided in this manual to keep the machine in good operating condition. Refer to the other materials received with the unit and to the service bulletins from the manufacturer for additional instructions on proper maintenance and service. Regular inspections and proper maintenance are essential to preventing accidents and injuries.



Keep the machine and the immediate work area clean. Do not use compressed air to remove dirt and debris from the machine. Foreign material may be propelled into the air and into operator or bystander causing personal injury.



Wear protective clothing, equipment and eye protection when making any adjustments or repairs to the machine.

A. The vertical slide should be cleaned with a vaporizing solvent and then lubricated with chassis grease once a month.

B. Check the adjustment of the duckhead once a month.

D. The table top, clamps, steel duckhead, and other working surfaces should be cleaned with a vaporizing solvent every month.

E. The clamps should be inspected and metal chips and dirt removed from the serrations with a wire brush once a month.

G. Make sure all fasteners are securely tightened.

H. Make certain that all guards and covers are in place.

I. Check for worn, damaged or missing parts including grips and protective covers. Replace them before allowing the unit to be used.

J. On a daily basis, inspect the unit and check to be certain that all systems are operating normally. Detailed inspection and testing procedures are specified for various components at regular intervals. Set up a chart and assign responsibility for these items.



Replace any damaged or missing safety decals. They are available from COATS, (800) 688-6359.

Important: These instructions will help you service the unit. Instructions are for a person with some mechanical ability and training. No attempt has been made to describe all basic steps. For example, how to loosen or tighten fasteners. Also basic procedures such as cycling systems and checking operation of the equipment are not fully described since they are known to anyone who does mechanical and service work. Do not attempt to perform work beyond your ability or at which you have no experience. If you need assistance, call an authorized service center or contact COATS directly, (800) 688-6359.

Installation Instructions



Proper unit installation is necessary for safe use and efficient operation. Proper installation also helps protect the unit from damage and makes service easier. Always place safety poster and instructions near the unit.

Location

Select a location that provides the operator with enough space to use the equipment in a safe manner. The area selected should be well lit, easy to clean and should be away from oil, grease, brake lathe chips, etc. Avoid areas where bystanders and customers may be present.

Floor Mounting

The machine should be securely bolted to the floor with suitable anchors using the hole at each corner of the machine base.

Assembly Instructions

Please inspect this unit for damage/missing parts prior to use.

Carton Contents (boxes marked 1 through 3):

Contains the base, tower and table top for your RC-50M Manual tire changer. Be sure to check all contents prior to assembly.

(Optional) Carton Contents (box marked 4):

Contains the Bead Loosener. Be sure to check all contents prior to assembly.

Base Assembly: Enclosed with base unit you will find 4 (four) anchor bolts (1/2" X 3") choose the location for the base at this time being sure to position the RC-50M in a clear working area. (It is suggested that the unit is firmly mounted to the floor prior to attaching the tower or table top.) Attach the tool tray to the base with supplied hardware.

Tower Assembly: Using the supplied hardware 4 (four) (12mm X 55mm hex bolts) that attaches the tower to the base of the RC-50M, position the tower in place. Attach the swing arm to the tower, (at this time it is suggested that grease be added to the pivot shaft.) The slider may be put into place at this time, (add the return spring prior to placing the slider in the swing-arm guide) once placed attach the bead head. Check travel, clearances and locking mechanism prior to use.

Table Top Installation: Prior to installation BE SURE TO PLACE THE TABLE TOP WITH THE LOCKING KNOB FACING FORWARD FOR ACCESS WHEN RC-50M IS IN USE. Once the table top has been positioned check all clearances for complete 360-degree rotation. Place wheel jaws at desired position, making sure to place

holding pin completely through the guild hole prior to locking the wheel in place.

Bead-head Adjustment: Prior to using your RC-50M you should take a few moments to check the alignment of the bead-head. This is a simple procedure that will require a 5mm hex wrench and an 18" wheel. Set the jaws in place to accept the 18" wheel (using a bare wheel will ease the adjustment process), tighten the jaws so that the wheel is held in place. Lower the bead head until contact is made between the plastic rim protector and top outer edge of the wheel. If they do not match-up, you'll need to make the following adjustment using both the setscrews (located on either side of the bead-head mounting base fig.1 item A) and the two adjusting screws (located side-by-side on the bead-head mounting base fig.1 item B) use the 5mm hex wrench to loosen the bead head setscrews. If needed rotate the head until contact is made with the wheel. The plastic protector should be touching the wheel as close to the center as possible. At this point do not tighten the setscrews; you'll want to check the alignment at rear of the bead-head. The rear portion of the bead head should overlap the outer edge of the wheel so that there is approximately 1-3mm overhang (fig. 2.) Once completed retighten the setscrews.

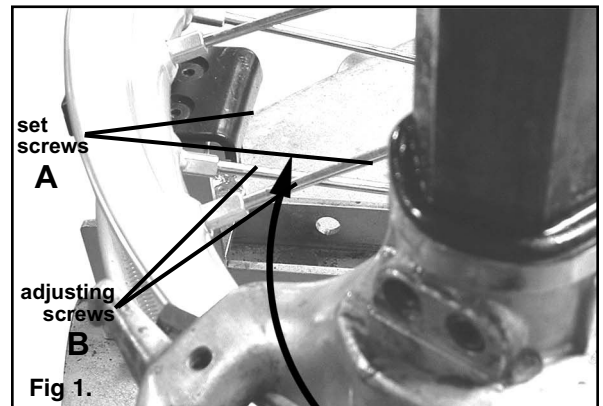

Assembly for (Optional) Bead Loosener: Check all contains prior to assembly. Attach support to the base using the supplied hardware. At this point you may now attach the link, breaker and lever arm to the support. The Bead Loosener will attach to the RC-50M by hooking on to the locating mount.

Parts List

PART NO. DESCRIPTION



85000717 MOUNT HEAD

PART NO. DESCRIPTION



85000722 NYLON NUT



85000718 O-RING



85000723 PIN



85000719 RIM PROTECTOR



85000724 ADJUSTER HEAD

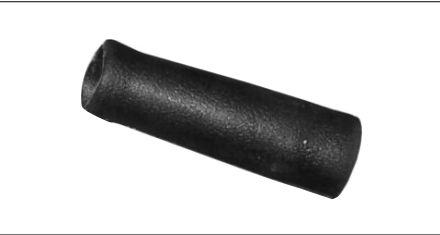

85000720 RUBBER GRIP



85000725 HANDLE



85000721 FLASH BOLT



8184712 PLASTIC BOOTIE

Notes

ONE WORD FOR SAFETY

R.I.M.

READ INSPECT MOUNT

READ...

Mounting and inflating the wrong size tire can get you hurt. *Read* the size on the tire and make sure it matches the rim. Be especially careful about putting a smaller tire on a larger rim, such as a 16-inch tire on a 16.5-inch rim.

Inflation of a mismatched tire and rim can cause an explosion.

INSPECT...

Before you put any tire on a rim, *inspect* the rim for rust, tough spots, bent edges, or cracks that could prevent the tire from seating right. If you spot any of these problems, don't mount the tire until the rim has been checked by your shop foreman.

Inspect the tire for bead damage.

MOUNT...

Once you've made sure the tire is OK and the right size and the rim is OK, *mount* the tire safely. NEVER, ever lean over the tire when you're inflating it. If a tire does explode, it will go straight up. You don't want to be over the tire if that happens. Also, never over-inflate the tire, even if the bead doesn't seat. Never inflate over 40 PSI. If the tire hasn't seated, something is wrong. Deflate the tire and check it and the rim again. If it doesn't work the second time, try another tire.

BE CAREFUL OF THESE SITUATIONS:

1. Damaged Bead or Beads.

2. Rusty Wheels.
(particularly in the bead seat area)

3. Bent or Cracked Wheels.

4 A. Mismatched.
(A mis-match of a 16-inch tire to a 16.5-inch rim causing an explosion)

4 B. Mismatched.
(16.5-inch tire on a 16-inch rim)

5. Walk-In Tire and Rim.

6. Back Injuries.

7. Hand or Finger Injuries.
(Hands or fingers too close to inflating tire or bead seats which may cause injury.)

8. Standing Clear.
(Never put any part of your body over the tire changer during inflation.)

9. Beads will not Seat at 40 PSI.

10. Improper Inflation.

Remember R.I.M. (Read, Inspect, Mount) for every tire.



FAILURE TO READ AND FOLLOW ALL WARNINGS AND INSTRUCTIONS IN THIS MANUAL CAN LEAD TO SERIOUS PERSONAL INJURY OR DEATH TO OPERATOR OR BYSTANDER.

THE OWNER IS RESPONSIBLE FOR MAINTAINING THE OPERATION INSTRUCTIONS AND DECALS FOR OPERATOR REFERENCE. FOR ADDITIONAL COPIES, CONTACT THE COATS® COMPANY, 1601 J.P. HENNESSY DRIVE, LAVERGNE, TENNESSEE, 37086 - (800) 688-6359.

TIRE FAILURE UNDER PRESSURE IS HAZARDOUS! This tire changer Will Not Restrain Exploding Tires, rims or other related equipment.

TIRES CAN EXPLODE, ESPECIALLY IF INFLATED BEYOND SPECIFIED LIMITS. DO NOT EXCEED TIRE MANUFACTURERS RECOMMENDED AIR PRESSURE.

AN EXPLODING TIRE, RIM, OR BEAD SEATING EQUIPMENT MAY PROPEL UPWARD AND OUTWARD WITH SUFFICIENT ENERGY TO CAUSE SERIOUS INJURY OR DEATH TO OPERATOR AND/OR BYSTANDERS.